

ESSENTIAL
COLLECTIONS

JULY 2023



VERVE

HYDRO
EXPRESS

FLAIR
FRAMELESS

SLIMLINE
CAPELLA

CARA

FLAIRSHOWERS.COM



DESIGNED TO SUIT YOUR **SPACE** AND YOUR **BUDGET**

For over 70 years Flair have been manufacturing shower doors and bathscreens for homeowners. Flair have built an expert knowledge of the industry and a comprehensive understanding of customer needs. The tradition of design excellence continues with the launch of our Essential Collections.

Flawless in design and technically perfect, Verve offers superb quality with a fast-fit system that is a firm favourite with professional installers.

Slimline Capella has a unique patented twist and lock system which provides wall profile adjustment of up to 100mm in certain door styles.

Flexibility is key to the Flair Frameless Concept. This cleverly designed range is suitable for both wetroom and shower tray application, Flair Frameless comes with the added benefit of our secure glass system - Failsafe Technology.

The Cara laminated glass shower door range is not just inclusively designed, it also offers the greatest standards of safety in the bathroom sector today.



**FLAIR
FRAMELESS**



SINCE
1952



OVER **70** YEARS



SPECIFICATION COMPARISON

A selection of our product features and specifications are summarised below to help you select the right range for every installation.

FLAIR ESSENTIAL COLLECTIONS

	VERVE	VERVE WETROOM	HYDRO EXPRESS
GLASS THICKNESS	6mm	8mm	Up to 6mm
DOOR HEIGHT	1900mm	1900mm	1850mm
HANDLE	Solid Chrome / Black Plated	–	Chrome Plated ABS
ROLLER WHEELS	Quick Release Double Wheel	–	Single Wheel Quick Release
GLASS COATING	Clean Easy	Clean Easy	–
COVER CAPS / STRIPS	Chrome / Black Plated	–	–
PVC - CLEAR SEALS	YES	YES	YES
ADJUSTMENT	Up to 50mm	Up to 15mm	Up to 50mm
FRAME COLOURS	Silver / Black	Silver / Black	Silver
FITTING / ASSEMBLY		–	
SHOWER TRAY COMPATIBLE	YES	YES	YES
WETROOM COMPATIBLE	–	YES	–
GUARANTEE	20 Years	20 Years	10 Years

	FLAIR FRAMELESS	SLIMLINE CAPELLA	CARA
GLASS THICKNESS	6mm	6mm	8mm
DOOR HEIGHT	1950mm	1950mm	1950mm / 975mm
HANDLE	Chrome / Black Plated	Chrome Plated	Chrome Plated
ROLLER WHEELS	–	Quick Release Double Wheel	–
GLASS COATING	Clearvue	Clearvue	Clearvue
COVER CAPS / STRIPS	Chrome / Black Plated	Chrome Plated	Chrome Plated
PVC-CLEAR SEALS	YES	YES	YES
ADJUSTMENT	Up to 50mm	Up to 100mm	Up to 50mm
FRAME COLOURS	Silver / Black	Silver	Silver
FITTING / ASSEMBLY	–		–
SHOWER TRAY COMPATIBLE	YES	YES	YES
WETROOM COMPATIBLE	YES	–	–
GUARANTEE	20 Years	20 Years	10 Years

TRUST FLAIR TRUST ESSENTIAL COLLECTIONS

The brand you can trust – at Flair, we understand the need for professional installers to choose and fit products they can rely on. The Flair Essential Collections is robustly engineered to provide assured long term performance.

EASY TO FIT

Flair's professional grade showering solutions have been developed to be quick and easy to fit. Our innovative installation designs mean that frames can be quickly put into place. We also provide user-friendly instructions and generous adjustments.

BUILT TO LAST

We invest in product design, materials and quality control to make sure our products stand the test of time and provide a true fit-and-forget solution.

UNRIVALLED CHOICE

Our showering range has something for every customer, every budget, style and space.

EXCEPTIONAL CUSTOMER SUPPORT

The success of Flair has been built upon exceptional service and support. From advising on product selection to quickly finding spare parts, our friendly team are here to help.



Subscribe to our YouTube channel to see for yourself why our Essential Collections are the first choice of installers.

CONTENTS

VERVE

1 Door Quadrant & Offset Quadrant	12
2 Door Quadrant & Offset Quadrant	14
Sliding Door	16
Level Access Sliding Door (VSASS)	18
Triple Panel Sliding Door	20
Bifold Door	22
Corner Entry	24
Pivot Door	28
Wetroom Screens	30

HYDRO EXPRESS

2 Door Quadrant & Offset Quadrant	36
Sliding Door	38
Corner Entry	40
Bifold Door	42
Pivot Door	44

BATHSCREENS

Verve 6mm Curved Bathscreens	48
Verve 6mm Square Bathscreens	50
Verve 8mm Bathscreens	52
Hydro Bathscreens	54
FBS Bathscreens	56

FLAIR FRAMELESS

Corner Pivot & Offset Corner Pivot Door	60
Pivot Door	62
Saloon Door	64
Curved Hinged Wetroom Panels	66
Hinged Rotating Wetroom Panels	68

SLIMLINE CAPELLA

Pivot Door	72
Sliding Door	74
Corner Entry & Offset Corner Entry	76
Bifold Door	78
2 Door Quadrant & Offset Quadrant	80

CARA

Corner Pivot Door	84
Corner Bifold Door	86
Bifold Door	88
Split Pivot Door	90
Saloon Door	92

SOUL Premium Grab Bar Collection

Straight Grab Bars	96
Straight Grab Bars With Rubber Grip	97
135° Angled Grab Bars	98
135° Angled Grab Bars With Rubber Grip	99
90° Angled Grab Bars	100
90° Angled Grab Bars With Rubber Grip	101

SLIMLINE SHOWER TRAYS SEE PAGE 104

ANTI-SLIP SHOWER TRAYS SEE PAGE 106

ULTRA SLIM SHOWER TRAYS SEE PAGE 108

ANTI-SLIP ULTRA SLIM SHOWER TRAYS SEE PAGE 109

SLIMLINE SHOWER TRAYS WITH TILING UPSTAND SEE PAGE 110

ACCESSORIES SEE PAGE 111

SHOWER DOOR MEASURING GUIDE SEE PAGE 112

VERVE

Verve is the latest modern Shower Door collection brought to you by Flair Showers. The range features minimalist profiles and a sleek contemporary handle design.

Verve products have 6mm toughened safety glass with Clearvue protective coating to repel unwanted grime and limescale. Each sliding door has quick release double rollers for ease of cleaning. Verve also features an innovative fast fit system that is a firm favourite with installers.

Affordable quality is the essence of the Verve collection.

Verve is available in silver & matte black anodised finish.

Verve Matte Black - Anodised Finish

Anodising is an electrochemical process that converts the metal surface to a durable, corrosion resistant, anodic oxide finish. The aluminium oxide finish is not just applied to the surface like a paint or plating, but it is fully integrated with the underlying aluminium substrate so that it cannot chip or peel. For Verve Matte Black, this means a superbly robust product that is designed for the busiest of bathroom environments.

KEY FEATURES

CLEARVUE HYDROPHOBIC COATING RESISTS THE BUILD UP OF GRIME AND LIMESCALE ON THE GLASS SURFACE



WITHOUT TREATMENT



WITH TREATMENT

<p>6mm TOUGHENED SAFETY GLASS</p>	<p>1900mm HEIGHT</p>	<p>UP TO 50mm PRODUCT ADJUSTMENT</p>	<p>SOLID CHROME HANDLE DESIGN</p>	<p>QUICK RELEASE CHROME DOUBLE WHEEL ROLLERS</p>	<p>30mm WALL PROFILE EXTENSION AVAILABLE</p>
<p>POSITIVE MAGNETIC CLOSE ACTION</p>	<p>CLEARVUE GLASS COATING</p>	<p>CHROME PLATED COVER CAPS</p>	<p>REVERSIBLE FOR LEFT OR RIGHT HANDED INSTALLATION</p>	<p>20 YEAR GUARANTEE</p>	

INSTALLERS CHOICE
REDUCING INSTALLATION TIME

EXPRESS FIT
QUICK FIT INSTALLATION

EXPRESS FIT - A simple and clever feature in the shower door design, making it quick and easy for the installer to assemble the product.

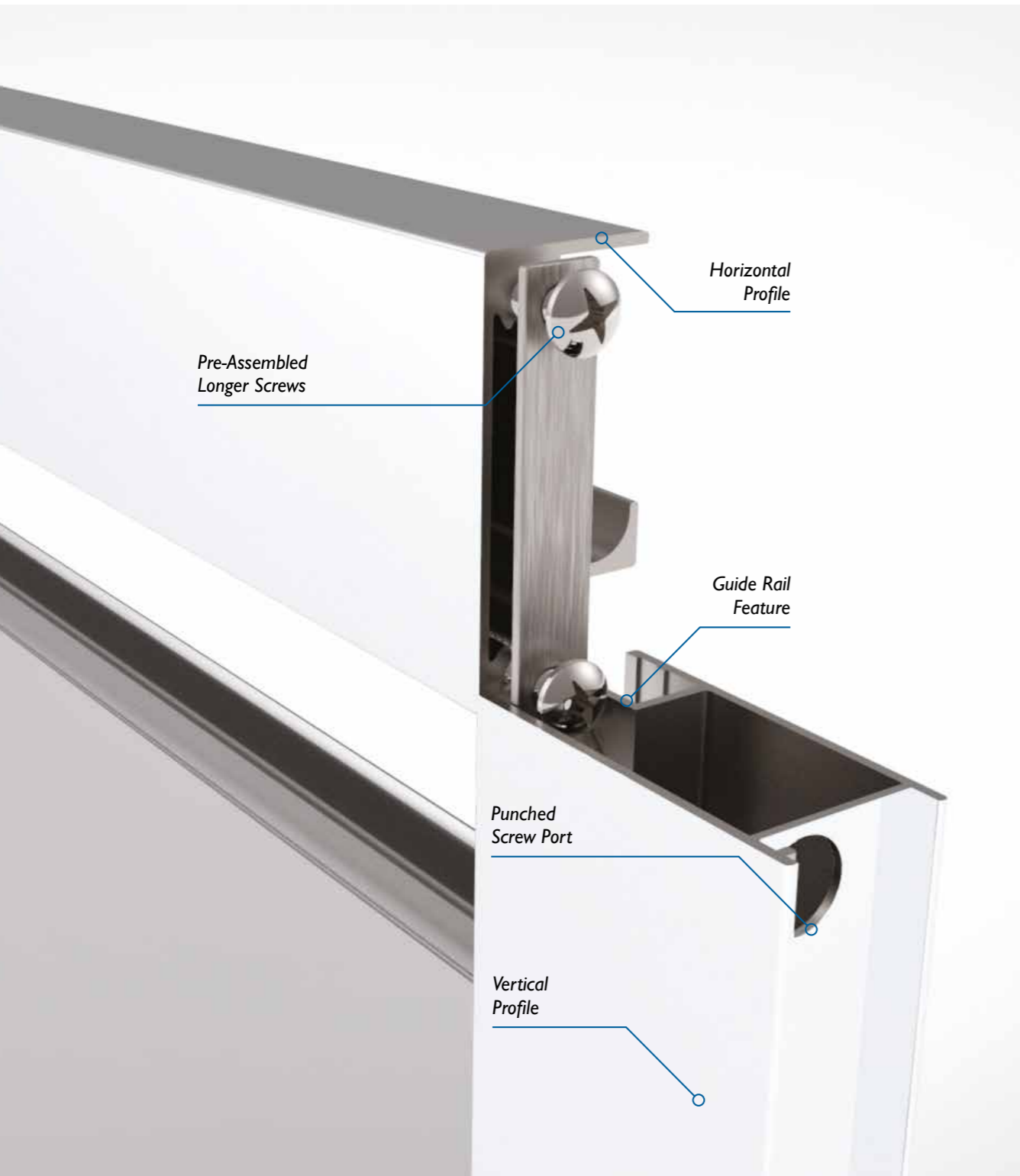

Our **EXPRESS FIT** design allows the installer to fit Verve in a quick and easy manner. We have pre-assembled the screws in the horizontal profile, leaving them ready to slot into place. The screw guide rail in the vertical profile makes it easier for the installer to secure the screws into position.

A simple and clever feature in the shower door design, making it quick and easy for the installer to assemble.



STEP 1

Align the horizontal and vertical shower door profiles together.



STEP 2

Slide pre-assembled screws into place on vertical profile, using the guide rails.



STEP 3

Tighten screws into position through the punched access port.

VERVE

1 DOOR QUADRANT & 1 DOOR OFFSET QUADRANT

COLOUR OPTIONS: ● SILVER ● BLACK

VERVE - 1 DOOR QUADRANT

DESCRIPTION	ADJUSTMENT SIZE		ACCESS	CODE - SILVER	CODE - BLACK
	MIN	MAX			
800mm	770mm	795mm	435mm	VOCQ80SC	VOCQ80BC
900mm	870mm	895mm	490mm	VOCQ90SC	VOCQ90BC
1000mm	970mm	995mm	490mm	VOCQ100SC	VOCQ100BC

VERVE - 1 DOOR OFFSET QUADRANT

DESCRIPTION	ADJUSTMENT SIZE		ACCESS	CODE - SILVER	CODE - BLACK
	MIN	MAX			
800 x 900mm	770-795mm	870-895mm	490mm	VOCQ80X90SC	- -
800 x 1000mm	770-795mm	970-995mm	490mm	VOCQ80X100SC	- -
900 x 1000mm	870-895mm	970-995mm	490mm	VOCQ90X100SC	- -
800 x 1200mm	770-795mm	1170-1195mm	490mm	VOCQ80X120SC	VOCQ80X120BC
900 x 1200mm	870-895mm	1170-1195mm	490mm	VOCQ90X120SC	VOCQ90X120BC



1 DOOR OFFSET QUADRANT SHOWER IN SILVER



1 DOOR OFFSET QUADRANT SHOWER IN BLACK



VERVE 1 DOOR OFFSET QUADRANT

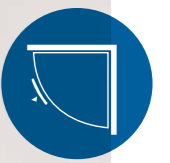
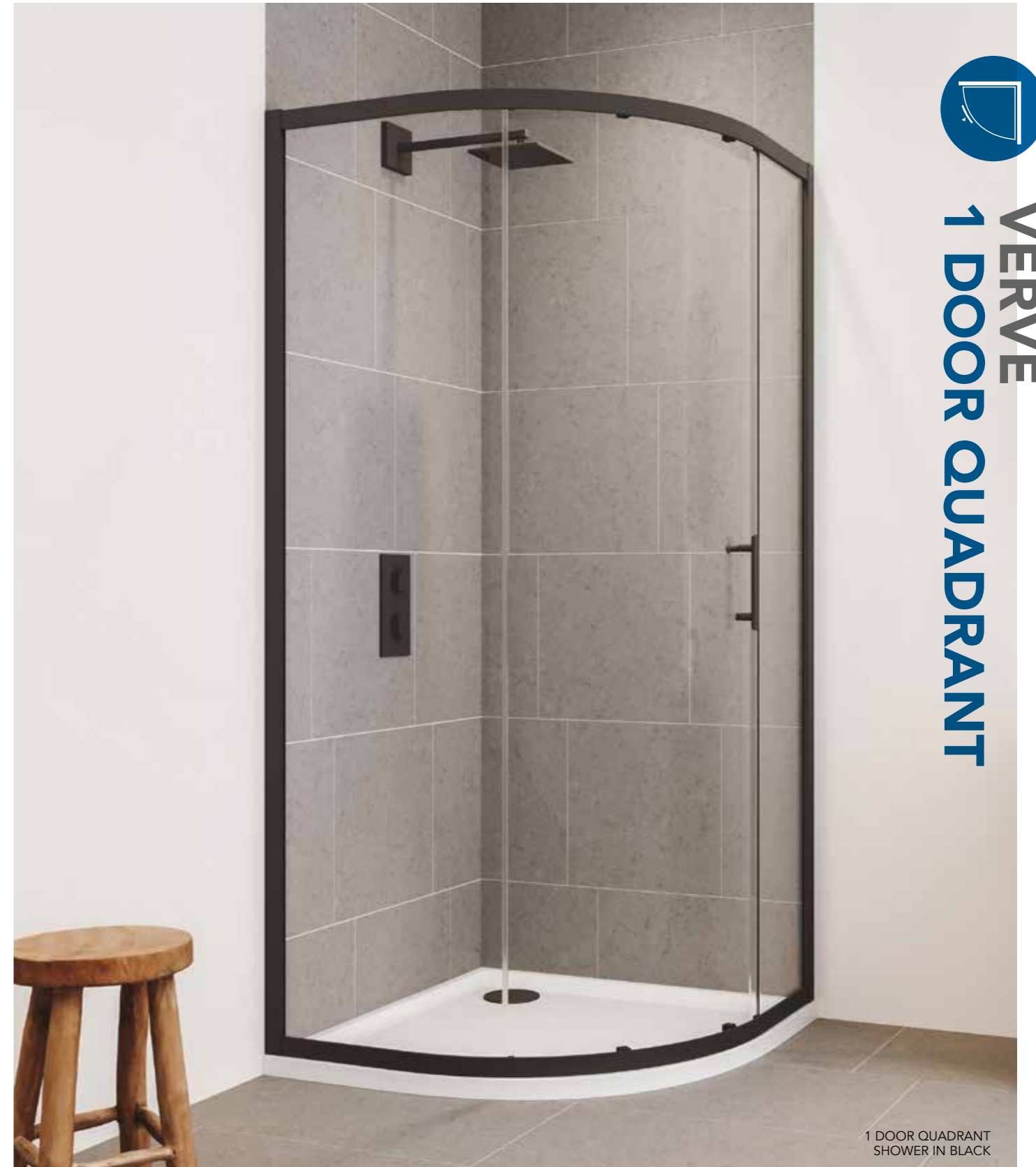

VERVE 1 DOOR QUADRANT

1 DOOR QUADRANT SHOWER IN BLACK

- 6mm** TOUGHENED SAFETY GLASS
- 1900mm** HEIGHT
- 25mm** PRODUCT ADJUSTMENT
- SOLID CHROME** HANDLE DESIGN
- QUICK RELEASE CHROME DOUBLE WHEEL ROLLERS**
- CLEARVUE GLASS COATING**
- CHROME PLATED COVER CAPS**
- REVERSIBLE FOR LEFT OR RIGHT HANDED INSTALLATION**

*All Flair Quadrant and Offset Quadrant trays have a 550mm radius.

VERVE

2 DOOR QUADRANT



2 DOOR QUADRANT - SILVER

- 6mm**
TOUGHENED SAFETY GLASS
- 1900mm**
HEIGHT
- 25mm**
PRODUCT ADJUSTMENT
- SOLID CHROME HANDLE DESIGN
- QUICK RELEASE CHROME DOUBLE WHEEL ROLLERS
- CLEARVUE GLASS COATING
- CHROME PLATED COVER CAPS

*All Flair Quadrant and Offset Quadrant trays have a 550mm radius.

VERVE 2 DOOR QUADRANT & 2 DOOR OFFSET QUADRANT

COLOUR OPTIONS: ● SILVER

VERVE - 2 DOOR QUADRANT

DESCRIPTION	ADJUSTMENT SIZE		ACCESS	CODE - SILVER
	MIN	MAX		
800mm	770mm	795mm	385mm	VCQ80SC
900mm	870mm	895mm	538mm	VCQ90SC

VERVE - 2 DOOR OFFSET QUADRANT

DESCRIPTION	ADJUSTMENT SIZE		ACCESS	CODE - SILVER
	MIN	MAX		
800 x 1000mm	770-795mm	970-995mm	468mm	VCQ80X100SC
800 x 1100mm	770-795mm	1070-1095mm	468mm	VCQ80X110SC
800 x 1200mm	770-795mm	1170-1195mm	468mm	VCQ80X120SC
900 x 1100mm	870-895mm	1070-1095mm	538mm	VCQ90X110SC
900 x 1200mm	870-895mm	1170-1195mm	538mm	VCQ90X120SC



STYLISH CHROME PLATED HANDLES



2 DOOR OFFSET QUADRANT - SILVER



VERVE 2 DOOR
OFFSET QUADRANT

VERVE SLIDING DOOR



SLIDING DOOR IN BLACK IN ALCOVE

VERVE SLIDING DOOR

COLOUR OPTIONS: ● SILVER ● BLACK

VERVE - SLIDING DOOR

DESCRIPTION	ADJUSTMENT SIZE		ACCESS	CODE - SILVER	CODE - BLACK
	MIN	MAX			
1000mm	950mm	1000mm	375mm	VSA100SC	VSA100BC
1100mm	1050mm	1100mm	425mm	VSA110SC	VSA110BC
1200mm	1150mm	1200mm	475mm	VSA120SC	VSA120BC
1300mm	1250mm	1300mm	525mm	VSA130SC	VSA130BC
1400mm	1350mm	1400mm	575mm	VSA140SC	VSA140BC
1500mm	1450mm	1500mm	575mm	VSA150SC	VSA150BC
1600mm	1550mm	1600mm	575mm	VSA160SC	VSA160BC
1700mm	1650mm	1700mm	575mm	VSA170SC	VSA170BC
1800mm	1750mm	1800mm	575mm	VSA180SC	-

VERVE - SEMI FRAMED SIDE PANELS

DESCRIPTION	ADJUSTMENT SIZE		CODE - SILVER	CODE - BLACK
	MIN	MAX		
700mm	670mm	695mm	VSP70SC	VSP70BC
760mm	730mm	755mm	VSP76SC	VSP76BC
800mm	770mm	795mm	VSP80SC	VSP80BC
900mm	870mm	895mm	VSP90SC	VSP90BC
1000mm	970mm	995mm	VSP100SC	VSP100BC

30mm Compensating Wall Profile included with every Verve Side Panel
Please note, when using a side panel, the maximum door adjustment is reduced by 25mm.

VERVE - PROFILE EXTENSION

DESCRIPTION	CODE - SILVER	CODE - BLACK
30mm Compensating Wall Profile	VCB30SC	VCB30BC

SLIDING DOOR IN BLACK WITH SIDE PANEL



SLIDING DOOR IN SILVER WITH SIDE PANEL

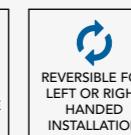
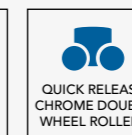
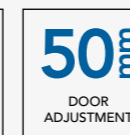
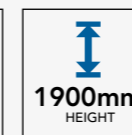

VERVE

LEVEL ACCESS SLIDING DOOR (VSASS)

COLOUR OPTION: ● SILVER

VERVE - LEVEL ACCESS SLIDING DOOR (VSASS)

DESCRIPTION	ADJUSTMENT SIZE		ACCESS	CODE - SILVER
	MIN	MAX		
1000mm - Left Hand	950mm	1000mm	380mm	VSASS100LSC
1000mm - Right Hand	950mm	1000mm	380mm	VSASS100RSC
1100mm - Left Hand	1050mm	1100mm	430mm	VSASS110LSC
1100mm - Right Hand	1050mm	1100mm	430mm	VSASS110RSC
1200mm - Left Hand	1150mm	1200mm	480mm	VSASS120LSC
1200mm - Right Hand	1150mm	1200mm	480mm	VSASS120RSC
1300mm - Left Hand	1250mm	1300mm	530mm	VSASS130LSC
1300mm - Right Hand	1250mm	1300mm	530mm	VSASS130RSC
1400mm - Left Hand	1350mm	1400mm	580mm	VSASS140LSC
1400mm - Right Hand	1350mm	1400mm	580mm	VSASS140RSC
1500mm - Left Hand	1450mm	1500mm	580mm	VSASS150LSC
1500mm - Right Hand	1450mm	1500mm	580mm	VSASS150RSC
1600mm - Left Hand	1550mm	1600mm	580mm	VSASS160LSC
1600mm - Right Hand	1550mm	1600mm	580mm	VSASS160RSC

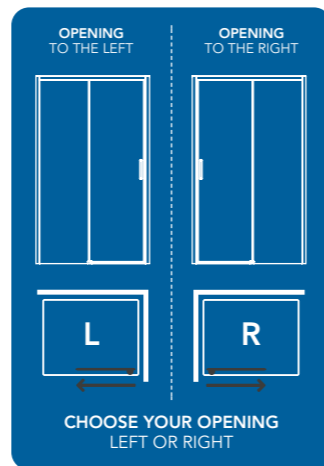

VERVE - SEMI FRAMED SIDE PANELS

DESCRIPTION	ADJUSTMENT SIZE		CODE - SILVER
	MIN	MAX	
700mm	670mm	695mm	VSP70SC
760mm	730mm	755mm	VSP76SC
800mm	770mm	795mm	VSP80SC
900mm	870mm	895mm	VSP90SC
1000mm	970mm	995mm	VSP100SC

30mm Compensating Wall Profile included with every Verve Side Panel
Please note, when using a side panel, the maximum door adjustment is reduced by 25mm.

VERVE - PROFILE EXTENSION

DESCRIPTION	CODE - SILVER
30mm Compensating Wall Profile	VCB30SC



VSASS FEATURES AN ANTI-JUMP MECHANISM
ENSURING DOOR REMAINS SECURELY ON THE TRACKS

- 6mm**
TOUGHENED
SAFETY GLASS
- 1900mm**
HEIGHT
- 50mm**
DOOR
ADJUSTMENT
- SOLID CHROME**
HANDLE DESIGN
- QUICK RELEASE**
BOTTOM
GUIDE
- POSITIVE**
MAGNETIC
CLOSE ACTION
- MINIMALIST**
THRESHOLD
BAR OF 6mm



VERVE
LEVEL ACCESS SLIDING DOOR



LEVEL ACCESS SLIDING DOOR
(RIGHT HAND) WITH SIDE PANEL

NEW PRODUCT

VERVE

TRIPLE PANEL SLIDING DOOR

COLOUR OPTION: ● SILVER

VERVE - TRIPLE PANEL SLIDING DOOR

DESCRIPTION	ADJUSTMENT SIZE		ACCESS	CODE - SILVER
	MIN	MAX		
900mm	850mm	900mm	430mm	V3SA90SC
1000mm	950mm	1000mm	497mm	V3SA100SC
1100mm	1050mm	1100mm	563mm	V3SA110SC
1200mm	1150mm	1200mm	630mm	V3SA120SC

VERVE - SEMI FRAMED SIDE PANELS

DESCRIPTION	ADJUSTMENT SIZE		ACCESS	CODE - SILVER
	MIN	MAX		
700mm	670mm	695mm		VSP70SC
760mm	730mm	755mm		VSP76SC
800mm	770mm	795mm		VSP80SC
900mm	870mm	895mm		VSP90SC
1000mm	970mm	995mm		VSP100SC

30mm Compensating Wall Profile included with every Verve Side Panel
Please note, when using a side panel, the maximum door adjustment is reduced by 25mm.

VERVE - PROFILE EXTENSION

DESCRIPTION	CODE - SILVER
30mm Compensating Wall Profile	VCB30SC



TRIPLE PANEL SLIDING DOOR IN ALCOVE



VERVE
TRIPLE PANEL SLIDING DOOR



TRIPLE PANEL SLIDING DOOR WITH SIDE PANEL

VERVE BIFOLD DOOR

COLOUR OPTIONS: ● SILVER ● BLACK

VERVE - BIFOLD DOOR

DESCRIPTION	ADJUSTMENT SIZE		ACCESS	CODE - SILVER	CODE - BLACK
	MIN	MAX			
700mm	650mm	700mm	413mm	VBF70SC	VBF70BC
760mm	710mm	760mm	473mm	VBF76SC	-
800mm	750mm	800mm	513mm	VBF80SC	VBF80BC
900mm	850mm	900mm	613mm	VBF90SC	VBF90BC
1000mm	950mm	1000mm	713mm	VBF100SC	VBF100BC

VERVE - SEMI FRAMED SIDE PANELS

DESCRIPTION	ADJUSTMENT SIZE		CODE - SILVER	CODE - BLACK
	MIN	MAX		
700mm	670mm	695mm	VSP70SC	VSP70BC
760mm	730mm	755mm	VSP76SC	VSP76BC
800mm	770mm	795mm	VSP80SC	VSP80BC
900mm	870mm	895mm	VSP90SC	VSP90BC
1000mm	970mm	995mm	VSP100SC	VSP100BC

30mm Compensating Wall Profile included with every Verve Side Panel
Please note, when using a side panel, the maximum door adjustment is reduced by 25mm.

VERVE - INLINE PANELS

DESCRIPTION	CODE - SILVER	CODE - BLACK
200mm	VIL20SC	VIL20BC
300mm	VIL30SC	VIL30BC
400mm	VIL40SC	VIL40BC
500mm	VIL50SC	VIL50BC

BLACK
INLINE
PANELS
NEW
FOR 2023

VERVE - PROFILE EXTENSION

DESCRIPTION	CODE - SILVER	CODE - BLACK
30mm Compensating Wall Profile	VCB30SC	VCB30BC



VERVE
BIFOLD
DOOR WITH
FRAMELESS
SIDE PANEL

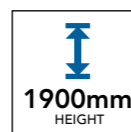

VERVE
BIFOLD DOOR

BIFOLD DOOR IN
BLACK IN ALCOVE

VERVE CORNER ENTRY

COLOUR OPTIONS: ● SILVER ● BLACK

VERVE - CORNER ENTRY

DESCRIPTION	ADJUSTMENT SIZE		ACCESS	CODE - SILVER	CODE - BLACK
	MIN	MAX			
700mm	670mm	695mm	340mm	VCE70SSC	-
760mm	730mm	755mm	382mm	VCE76SSC	-
800mm	770mm	795mm	410mm	VCE80SSC	VCE80SBC
900mm	870mm	895mm	485mm	VCE90SSC	VCE90SBC
1000mm	970mm	995mm	551mm	VCE100SSC	-
1200mm	1170mm	1195mm	551mm	VCE120SSC	-



Note: Verve Corner entry is a two box product, code on both boxes are the same.



CORNER ENTRY
BLACK



CORNER ENTRY - SILVER

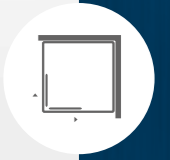

VERVE
CORNER ENTRY

- 6E TOUGHENED SAFETY GLASS
- 1900mm HEIGHT
- 25mm PRODUCT ADJUSTMENT
- SOLID CHROME HANDLE DESIGN
- QUICK RELEASE CHROME DOUBLE WHEEL ROLLERS
- CLEARVUE GLASS COATING
- CHROME PLATED COVER CAPS



VERVE
PIVOT DOOR
AND
INLINE PANEL



VERVE
PIVOT DOOR AND INLINE PANEL

**INSTALLERS
CHOICE**
REDUCING INSTALLATION TIME

**EXPRESS
FIT**
QUICK FIT INSTALLATION



VERVE PIVOT DOOR

PIVOT DOOR IN BLACK
IN ALCOVE



EXPRESS FIT
QUICK FIT INSTALLATION

INSTALLERS CHOICE
REDUCING INSTALLATION TIME

VERVE PIVOT DOOR

COLOUR OPTIONS: ● SILVER ● BLACK

VERVE - PIVOT DOOR

DESCRIPTION	ADJUSTMENT SIZE		ACCESS	CODE - SILVER	CODE - BLACK
	MIN	MAX			
700mm	650mm	700mm	417mm	VPD70SC	-
760mm	710mm	760mm	477mm	VPD76SC	-
800mm	750mm	800mm	517mm	VPD80SC	VPD80BC
900mm	850mm	900mm	617mm	VPD90SC	VPD90BC
1000mm	950mm	1000mm	717mm	VPD100SC	VPD100BC

VERVE - SEMI FRAMED SIDE PANELS

DESCRIPTION	ADJUSTMENT SIZE		CODE - SILVER	CODE - BLACK
	MIN	MAX		
700mm	670mm	695mm	VSP70SC	VSP70BC
760mm	730mm	755mm	VSP76SC	VSP76BC
800mm	770mm	795mm	VSP80SC	VSP80BC
900mm	870mm	895mm	VSP90SC	VSP90BC
1000mm	970mm	995mm	VSP100SC	VSP100BC

30mm Compensating Wall Profile included with every Verve Side Panel
Please note, when using a side panel, the maximum door adjustment is reduced by 25mm.

VERVE - INLINE PANELS

DESCRIPTION	CODE - SILVER	CODE - BLACK
200mm	VIL20SC	VIL20BC
300mm	VIL30SC	VIL30BC
400mm	VIL40SC	VIL40BC
500mm	VIL50SC	VIL50BC

**BLACK
INLINE
PANELS
NEW
FOR 2023**

VERVE - PROFILE EXTENSION

DESCRIPTION	CODE - SILVER	CODE - BLACK
30mm Compensating Wall Profile	VCB30SC	VCB30BC



- 6mm** TOUGHENED SAFETY GLASS
- 1900mm** HEIGHT
- 50mm** PRODUCT ADJUSTMENT
- REVERSIBLE FOR LEFT OR RIGHT HANDED INSTALLATION
- SOLID CHROME HANDLE DESIGN
- QUALITY ENGINEERED HINGE
- POSITIVE MAGNETIC CLOSE ACTION



PIVOT DOOR IN SILVER WITH SIDE PANEL

VERVE WETROOM SCREENS

Choose a Verve wetroom for a luxurious walk-in shower experience. These versatile screens are suitable for shower tray or wetroom floor application.

Verve wetroom panels are constructed from 8mm toughened safety glass and offer superb quality.



<p>8mm TOUGHENED SAFETY GLASS</p>	<p>1900mm HEIGHT</p>	<p>CLEARVUE GLASS COATING</p>
<p>UP TO 15mm PRODUCT ADJUSTMENT</p>	<p>1m CHROME STABILISING BAR INCLUDED</p>	<p>SUITABLE FOR SHOWER TRAY OR WETROOM FLOOR APPLICATION</p>

Please Note;
Rotating
wetroom
panel sold
separately

COLOUR OPTION: ● SILVER

VERVE - SILVER FINISH - WETROOMS

DESCRIPTION	ADJUSTMENT SIZE		CODE - SILVER
	MIN	MAX	
700mm Wetroom	675mm	690mm	VWR70SC
800mm Wetroom	775mm	790mm	VWR80SC
900mm Wetroom	875mm	890mm	VWR90SC
1000mm Wetroom	975mm	990mm	VWR100SC
1200mm Wetroom	1175mm	1190mm	VWR120SC
1400mm Wetroom	1375mm	1390mm	VWR140SC

Supplied with 1m straight stabilising bar

VERVE - SILVER FINISH - ROTATING WETROOM PANELS

DESCRIPTION	CODE - SILVER
300mm Rotating Wetroom Panel	VRP30SC

VERVE - T-PIECE STABILISING BAR

DESCRIPTION	CODE - SILVER
T-Piece	S-VWRTS

Purchased separately if fitted with a side panel

VERVE WETROOM SCREENS



COLOUR OPTION: ● BLACK

VERVE - MATTE BLACK WETROOM PROFILE KIT

DESCRIPTION	ADJUSTMENT SIZE		CODE - BLACK
	MIN	MAX	
900mm Wetroom	875mm	890mm	VWRBLACK KIT

Supplied with 1m straight stabilising bar

VERVE - T-PIECE STABILISING BAR

DESCRIPTION	CODE - BLACK
T-Piece	S-VVRTBLK

Purchased separately if fitted with a side panel

Please note: VERVE matte black wetroom kit is not suitable for installation with return panel.

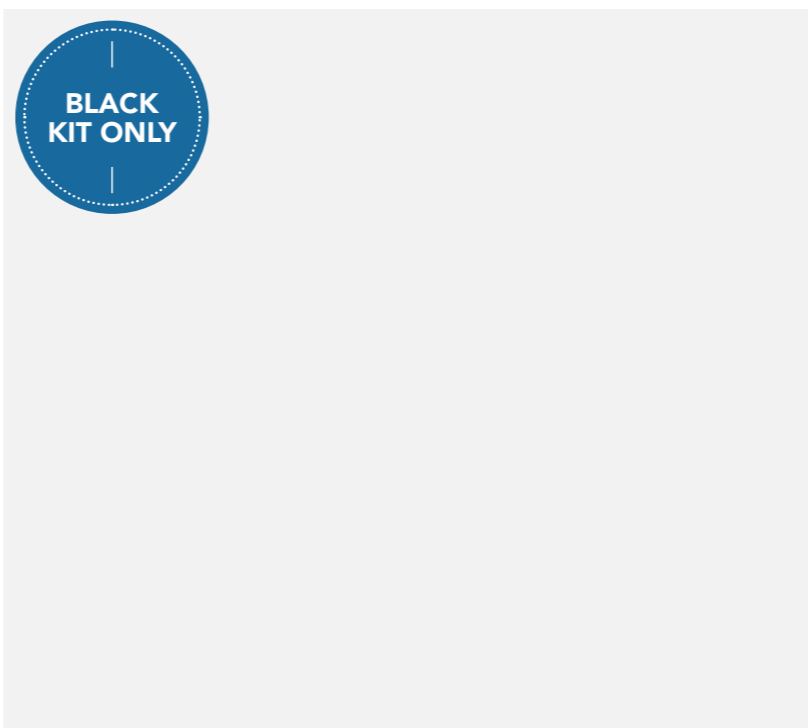

HYDRO

EXPRESS

Hydro express is an exciting remodel of Hydro - a tried and trusted brand brought to you by Flair Showers. Hydro's new design is crisp and contemporary with sleek modern handles and minimalist silver profiles.

Each door is 1850mm high and features up to 6mm toughened safety glass. Quick release rollers ensure easy cleaning while magnetic seals provide a watertight close.

This innovative range also boasts an express fit mechanism that is a firm favourite with installers.

Hydro Express - Designed to suit your space and budget.

KEY FEATURES

UP TO 6mm TOUGHENED SAFETY GLASS	1850mm HEIGHT	UP TO 50mm PRODUCT ADJUSTMENT	30mm WALL PROFILE EXTENSION AVAILABLE	
CHROME PLATED ABS HANDLES	QUICK RELEASE SINGLE WHEEL ROLLER	POSITIVE MAGNETIC CLOSE ACTION	REVERSIBLE FOR LEFT OR RIGHT HANDED INSTALLATION	10 YEAR GUARANTEE

**INSTALLERS
CHOICE**
REDUCING INSTALLATION TIME

**EXPRESS
FIT**
QUICK FIT INSTALLATION

HYDRO EXPRESS 2 DOOR QUADRANT & OFFSET QUADRANT

COLOUR OPTION: ● SILVER

HYDRO EXPRESS - 2 DOOR QUADRANT

DESCRIPTION	ADJUSTMENT SIZE		ACCESS	CODE - SILVER
	MIN	MAX		
800mm	770mm	795mm	395mm	HYCQ80SC
900mm	870mm	895mm	545mm	HYCQ90SC

HYDRO EXPRESS - OFFSET QUADRANT

DESCRIPTION	ADJUSTMENT SIZE		ACCESS	CODE - SILVER
	MIN	MAX		
800 x 1000mm	770-795mm	970-995mm	475mm	HYCQ80X100SC
800 x 1200mm	770-795mm	1170-1195mm	475mm	HYCQ80X120SC
900 x 1200mm	870-895mm	1170-1195mm	545mm	HYCQ90X120SC



CONTEMPORARY
HANDLE DESIGN



**HYDRO EXPRESS
OFFSET QUADRANT**

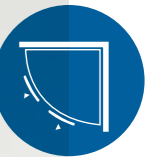

**HYDRO EXPRESS
2 DOOR QUADRANT**

1850mm
HEIGHT

25mm
PRODUCT
ADJUSTMENT

CHROME PLATED
ABS HANDLES

QUICK RELEASE
SINGLE WHEEL
ROLLERS

POSITIVE
MAGNETIC
CLOSE ACTION

REVERSIBLE FOR
LEFT OR RIGHT
HANDED
INSTALLATION

HYDRO EXPRESS SLIDING DOOR

COLOUR OPTION: ● SILVER



QUICK RELEASE
BOTTOM ROLLERS

HYDRO EXPRESS - SLIDING DOOR

DESCRIPTION	ADJUSTMENT SIZE		ACCESS	CODE - SILVER
	MIN	MAX		
1000mm	950mm	1000mm	376mm	HYSA100SC
1100mm	1050mm	1100mm	426mm	HYSA110SC
1200mm	1150mm	1200mm	476mm	HYSA120SC

HYDRO EXPRESS - SEMI FRAMED SIDE PANELS

DESCRIPTION	ADJUSTMENT SIZE		CODE - SILVER
	MIN	MAX	
700mm	670mm	695mm	HYSP70SC
760mm	730mm	755mm	HYSP76SC
800mm	770mm	795mm	HYSP80SC
900mm	870mm	895mm	HYSP90SC
1000mm	970mm	995mm	HYSP100SC

Please note, when using a side panel, the maximum door adjustment is reduced by 25mm.

HYDRO EXPRESS - PROFILE EXTENSION

DESCRIPTION	CODE - SILVER
30mm Compensating Wall Profile	HYCB30SC

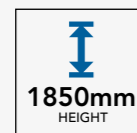

HYDRO EXPRESS
SLIDING DOOR



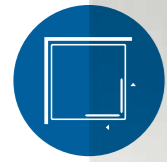

HYDRO EXPRESS CORNER ENTRY



HYDRO EXPRESS CORNER ENTRY

COLOUR OPTION: ● SILVER



HYDRO EXPRESS - CORNER ENTRY

DESCRIPTION	ADJUSTMENT SIZE		ACCESS	CODE - SILVER
	MIN	MAX		
760mm	730mm	755mm	387mm	HYCE76SC
800mm	770mm	795mm	415mm	HYCE80SC
900mm	870mm	895mm	486mm	HYCE90SC

CONTEMPORARY
HANDLE DESIGN



QUICK RELEASE
BOTTOM ROLLERS

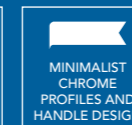

HYDRO EXPRESS BIFOLD DOORS

COLOUR OPTION: ● SILVER

HYDRO EXPRESS - BIFOLD DOOR

DESCRIPTION	ADJUSTMENT SIZE		ACCESS	CODE - SILVER
	MIN	MAX		
760mm	710mm	760mm	475mm	HYBF76SC
800mm	750mm	800mm	515mm	HYBF80SC
900mm	850mm	900mm	615mm	HYBF90SC
1000mm	950mm	1000mm	715mm	HYBF100SC

HYDRO EXPRESS - SEMI FRAMED SIDE PANELS

DESCRIPTION	ADJUSTMENT SIZE		CODE - SILVER
	MIN	MAX	
700mm	670mm	695mm	HYSP70SC
760mm	730mm	755mm	HYSP76SC
800mm	770mm	795mm	HYSP80SC
900mm	870mm	895mm	HYSP90SC
1000mm	970mm	995mm	HYSPI00SC

Please note, when using a side panel, the maximum door adjustment is reduced by 25mm.

HYDRO EXPRESS - PROFILE EXTENSION

DESCRIPTION	CODE - SILVER
30mm Compensating Wall Profile	HYCB30SC



BIFOLD DOOR
WITH SIDE PANEL



HYDRO EXPRESS
BIFOLD DOORS

**INSTALLERS
CHOICE**
REDUCING INSTALLATION TIME

**EXPRESS
FIT**
QUICK FIT INSTALLATION

↑
↓
1850mm
HEIGHT

50mm
DOOR
ADJUSTMENT

↑
↓
CHROME PLATED
HANDLES

↻
POSITIVE
MAGNETIC
CLOSE ACTION

↻
REVERSIBLE FOR
LEFT OR RIGHT
HANDED
INSTALLATION



HYDRO EXPRESS PIVOT DOOR



HYDRO EXPRESS PIVOT DOOR

COLOUR OPTION: ● SILVER

HYDRO EXPRESS - PIVOT DOOR

DESCRIPTION	ADJUSTMENT SIZE		CODE - SILVER	
	MIN	MAX		
760mm	710mm	760mm	477mm	HYPD76SC
800mm	750mm	800mm	517mm	HYPD80SC
900mm	850mm	900mm	617mm	HYPD90SC

HYDRO EXPRESS - SEMI FRAMED SIDE PANELS

DESCRIPTION	ADJUSTMENT SIZE		CODE - SILVER
	MIN	MAX	
700mm	670mm	695mm	HYSP70SC
760mm	730mm	755mm	HYSP76SC
800mm	770mm	795mm	HYSP80SC
900mm	870mm	895mm	HYSP90SC
1000mm	970mm	995mm	HYSP100SC

Please note, when using a side panel, the maximum door adjustment is reduced by 25mm.

HYDRO EXPRESS - PROFILE EXTENSION

DESCRIPTION	CODE - SILVER
30mm Compensating Wall Profile	HYCB30SC

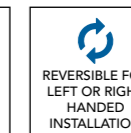
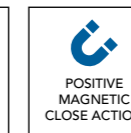
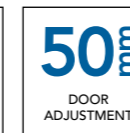
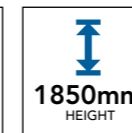

A large, stylized letter 'B' in a dark blue color, positioned on the left side of the page. The 'B' is composed of a solid dark blue shape with a white negative space forming the letter's structure. The top and bottom horizontal bars of the 'B' are rounded on their right ends, while the vertical stem is straight. The right side of the 'B' is a large, white, curved shape that points towards the right, creating a sense of depth and movement.

BATHSCREENS

Flair offers an unrivalled selection of innovative bath screen designs.

From simple curved shapes to more angular designs with clever shelf options, there is something to suit every bathroom.

Verve 6mm Curved Bathscreens	48
Verve 6mm Square Bathscreens	50
Verve 8mm Bathscreens	52
Hydro Bathscreens	54
FBS Bathscreens	56

VERVE

CURVED BATHSCREENS

IMPORTANT NOTE:

- These Bathscreens are a water deflector and splash proof only.
- It is advised that all Bathscreens are fitted to the inside edge of the bath to ensure maximum effectiveness.



6MM CURVED 2 PANEL BATHSCREEN - 1 FIXED & 1 ROTATING PANEL - VBS7SC



6MM CURVED 2 PANEL ROTATING BATHSCREEN - VBS5SC



6MM CURVED ROTATING BATHSCREEN - VBS1SC



6MM CURVED ROTATING BATHSCREEN MATTE BLACK - VBS1BC



6MM SAIL BATHSCREEN WITH TOWEL RAIL- VBS12SC



6MM CURVED ROTATING BATHSCREEN WITH TOWEL RAIL - VBS3SC

VERVE - CURVED BATHSCREENS

DESCRIPTION	HEIGHT	WIDTH	COLOUR	CODE
6mm Single Panel Rotating Bathscreen (Radius Edge)	1400mm	800mm	Silver	VBS1SC
6mm Single Panel Rotating Bathscreen (Radius Edge)	1400mm	800mm	Matte Black	VBS1BC
6mm Curved Rotating Bathscreen with Towel Rail	1500mm	800mm	Silver	VBS3SC
6mm Curved 2 Panel Bathscreen - 1 Fixed & 1 Rotating Panel	1500mm	900mm	Silver	VBS7SC
6mm Sail Bathscreen with Towel Rail	1500mm	800mm	Silver	VBS12SC
6mm Curved 2 Panel Rotating Bathscreen	1500mm	900mm	Silver	VBS5SC

- 6mm** TOUGHENED SAFETY GLASS
- CLEARVUE GLASS COATING
- UP TO **15mm** PRODUCT ADJUSTMENT
- REVERSIBLE FOR LEFT OR RIGHT HANDED INSTALLATION
- 20 YEAR GUARANTEE

VERVE

SQUARE BATHSCREENS

IMPORTANT NOTE:

- These Bathscreens are a water deflector and splash proof only.
- It is advised that all Bathscreens are fitted to the inside edge of the bath to ensure maximum effectiveness.



6mm 2 PANEL BATHSCREEN -
1 FIXED & 1 ROTATING PANEL - VBS8SC



6mm ROTATING BATHSCREEN -
SQUARE EDGE - VBS2SC



6mm ROTATING BATHSCREEN -
SQUARE EDGE WITH TOWEL RAIL - VBS4SC



6mm FIXED BATHSCREEN WITH
CHROME ANGLED SUPPORT BAR - VBS10SC



6mm 2 PANEL BATHSCREEN -
BOTH PANELS ROTATING - VBS6SC

VERVE - SQUARE BATHSCREENS

DESCRIPTION	HEIGHT	WIDTH	COLOUR	CODE
6mm 2 Panel Bathscreen - 1 Fixed & 1 Rotating Panel	1500mm	900mm	Silver	VBS8SC
6mm Rotating Bathscreen - Square Edge	1400mm	800mm	Silver	VBS2SC
6mm Fixed Bathscreen with Chrome Angled Support Bar	1400mm	850mm	Silver	VBS10SC
6mm Rotating Bathscreen - Square Edge with Towel Rail	1500mm	800mm	Silver	VBS4SC
6mm 2 Panel Bathscreen - Both Panels Rotating	1500mm	900mm	Silver	VBS6SC

- 6mm**
TOUGHENED
SAFETY GLASS
- CLEARVUE**
GLASS
COATING
- UP TO
15mm
PRODUCT
ADJUSTMENT
- REVERSIBLE FOR
LEFT OR RIGHT
HANDED
INSTALLATION
- 20 YEAR
GUARANTEE

IMPORTANT NOTE:

- These Bathscreens are a water deflector and splash proof only.
- It is advised that all Bathscreens are fitted to the inside edge of the bath to ensure maximum effectiveness.

VERVE

8MM BATHSCREENS



8MM 2 PANEL BATHSCREEN (1 FIXED PANEL / 1 ROTATING PANEL - SQUARE EDGE) - SILVER - VBS13SC



8MM 2 PANEL BATHSCREEN (1 FIXED PANEL / 1 ROTATING PANEL - SQUARE EDGE) - MATTE BLACK - VBS13BC



VERVE - 8MM BATHSCREENS

DESCRIPTION	HEIGHT	WIDTH	COLOUR	CODE
8mm 2 Panel Bathscreen - 1 Fixed Panel / Rotating Panel - Square Edge	1500mm	900mm	Silver	VBS13SC
8mm 2 Panel Bathscreen - 1 Fixed Panel / Rotating Panel - Square Edge	1500mm	900mm	Matte Black	VBS13BC

8mm

TOUGHENED SAFETY GLASS



CLEARVUE GLASS COATING



MAGNETIC SEALS



INWARD ROTATING PANEL UP TO 180°



REVERSIBLE FOR LEFT OR RIGHT HANDED INSTALLATION



20 YEAR GUARANTEE

HYDRO

4 & 5 PANEL BATHSCREENS

IMPORTANT NOTE:

- These Bathscreens are a water deflector and splash proof only.
- It is advised that all Bathscreens are fitted to the inside edge of the bath to ensure maximum effectiveness.



4 PANEL BATH SCREEN



5 PANEL BATHSCREEN

HYDRO - BATHSCREENS

DESCRIPTION	HEIGHT	WIDTH	COLOUR	CODE
4 Panel Bathscreen	1400mm	850mm	Silver	PBSG4SC
5 Panel Bathscreen	1400mm	1050mm	Silver	PBSG5SC
5 Panel Bathscreen	1400mm	1050mm	White	PBSG5WC

BATH PANELS

High gloss acrylic white bath panels.



BATH PANELS

DESCRIPTION	HEIGHT	WIDTH	COLOUR	CODE
Front Bath Panel	533mm	1700mm	White	BP5FWH
End Bath Panel	533mm	711mm	White	BP5EWH

FBS BATHSCREENS

IMPORTANT NOTE:

- These Bathscreens are a water deflector and splash proof only.
- It is advised that all Bathscreens are fitted to the inside edge of the bath to ensure maximum effectiveness.



FBS BATHSCREENS

DESCRIPTION	HEIGHT	WIDTH	COLOUR	CODE
6mm Single Panel Sail Bathscreen	1430mm	850mm	Silver	FBS1SC
6mm Single Panel Square Bathscreen	1430mm	850mm	Silver	FBS3SC
6mm Double Panel Square Bathscreen with Shelves	1430mm	1050mm	Silver	FBS5SC
8mm 2 Panel Square Bathscreen Fixed Rotating	1400mm	900mm	Silver	CYBSSQ2S

FLAIR FRAMELESS

Flexibility is key to the Flair Frameless Concept.

This cleverly designed range is suitable for both wetroom and shower tray application.

CLEARVUE HYDROPHOBIC COATING
RESISTS THE BUILD UP OF GRIME AND
LIMESCALE ON THE GLASS SURFACE



WITHOUT
TREATMENT

WITH
TREATMENT



KEY FEATURES

<p>6mm TOUGHENED SAFETY GLASS</p>	<p>1950mm HEIGHT</p>	<p>POSITIVE MAGNETIC CLOSE ACTION</p>	<p>RISING BUTT HINGE MECHANISM FOR SMOOTH MOVEMENT</p>	<p>SILVER & MATTE BLACK OPTIONS AVAILABLE SELECTED DOOR STYLES</p>
<p>CLEARVUE GLASS COATING</p>	<p>UPTO 25mm WALL PROFILE EXTENSION AVAILABLE</p>	<p>REVERSIBLE FOR LEFT OR RIGHT HANDED INSTALLATION</p>	<p>EASY ACCESS SOLUTION</p>	<p>20 YEAR GUARANTEE</p>



FLAIR FRAMELESS CORNER PIVOT DOORS



CORNER PIVOT
DOOR IN SILVER

FLAIR FRAMELESS CORNER PIVOT DOOR & OFFSET CORNER PIVOT DOOR

COLOUR OPTION: ● SILVER

FLAIR FRAMELESS - CORNER PIVOT DOOR

DESCRIPTION	ADJUSTMENT SIZE		ACCESS	CODE - SILVER
	MIN	MAX		
800mm	765mm	790mm	880mm	FFCPD80SC
900mm	865mm	890mm	1080mm	FFCPD90SC
1000mm	965mm	990mm	1280mm	FFCPD100SC

FLAIR FRAMELESS - OFFSET CORNER PIVOT DOOR

DESCRIPTION	ADJUSTMENT SIZE		ACCESS	CODE - SILVER
	MIN	MAX		
1000 x 800mm	765-965mm	790-990mm	640mm	FFCPD100x80SC
1200 x 800mm	765-1165mm	790-1190mm	640mm	FFCPD120x80SC
1200 x 900mm	865-1165mm	890-1190mm	740mm	FFCPD120x90SC

FLAIR FRAMELESS - INLINE PANELS

DESCRIPTION	CODE - SILVER
200mm	FFIL20SC
300mm	FFIL30SC
400mm	FFIL40SC
200mm with 3 Shelves	FFILS20SC
300mm with 3 Shelves	FFILS30SC
400mm with 3 Shelves	FFILS40SC



OFFSET
CORNER
PIVOT DOOR
IN SILVER

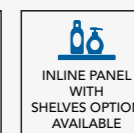
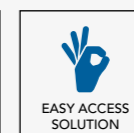
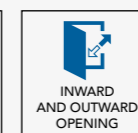
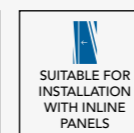
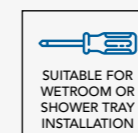
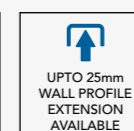
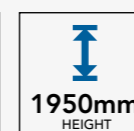



FLAIR FRAMELESS PIVOT DOOR



PIVOT DOOR IN BLACK IN ALCOVE

FLAIR FRAMELESS PIVOT DOOR

COLOUR OPTIONS: ● SILVER ● BLACK

FLAIR FRAMELESS - PIVOT DOOR

DESCRIPTION	ADJUSTMENT SIZE		ACCESS	CODE - SILVER	CODE - BLACK
	MIN	MAX			
700mm	650mm	700mm	540mm	FFPD70SC	FFPD70BC
800mm	750mm	800mm	640mm	FFPD80SC	FFPD80BC
900mm	850mm	900mm	740mm	FFPD90SC	FFPD90BC
1000mm	950mm	1000mm	840mm	FFPD100SC	FFPD100BC

FLAIR FRAMELESS - SEMI FRAMED SIDE PANELS

DESCRIPTION	ADJUSTMENT SIZE		CODE - SILVER	CODE - BLACK
	MIN	MAX		
700mm	665mm	690mm	FFSP70SC	FFSP70BC
760mm	725mm	750mm	FFSP76SC	-
800mm	765mm	790mm	FFSP80SC	FFSP80BC
900mm	865mm	890mm	FFSP90SC	FFSP90BC
1000mm	965mm	990mm	FFSP100SC	FFSP-
100BC				

FLAIR FRAMELESS - INLINE PANELS

DESCRIPTION	CODE - SILVER	CODE - BLACK
200mm	FFIL20SC	FFIL20BC
300mm	FFIL30SC	FFIL30BC
400mm	FFIL40SC	FFIL40BC
200mm with 3 Shelves	FFILS20SC	-
300mm with 3 Shelves	FFILS30SC	-
400mm with 3 Shelves	FFILS40SC	-

FLAIR FRAMELESS - PROFILE EXTENSION

DESCRIPTION	CODE - SILVER	CODE - BLACK
10mm Compensating Wall Profile	FFCB10SC	FFCB10BG
25mm Compensating Wall Profile	FFCB25SC	FFCB25BG

6mm

TOUGHENED SAFETY GLASS

1950mm

HEIGHT

UP TO **50mm**

PRODUCT ADJUSTMENT

UPTO 25mm WALL PROFILE EXTENSION AVAILABLE

SILVER & MATTE BLACK OPTIONS AVAILABLE SELECTED DOOR STYLES

SUITABLE FOR WETROOM OR SHOWER TRAY INSTALLATION

SUITABLE FOR INSTALLATION WITH 2 INLINE PANELS

INWARD AND OUTWARD OPENING

EASY ACCESS SOLUTION

PIVOT DOOR IN SILVER WITH SIDE PANEL



FLAIR FRAMELESS SALOON DOOR

COLOUR OPTIONS: ● SILVER ● BLACK

FLAIR FRAMELESS - SALOON DOOR

DESCRIPTION	CODE - SILVER	CODE - BLACK
800mm 750mm 800mm 590mm	FFSD80SC	FFSD80BC
900mm 850mm 900mm 690mm	FFSD90SC	FFSD90BC
1000mm 950mm 1000mm 790mm	FFSD100SC	FFSD100BC
1200mm 1150mm 1200mm 990mm	FFSD120SC	FFSD120BC

FLAIR FRAMELESS - SEMI FRAMED SIDE PANELS

DESCRIPTION	ADJUSTMENT SIZE MIN MAX	CODE - SILVER	CODE - BLACK
700mm	665mm 690mm	FFSP70SC	FFSP70BC
760mm	725mm 750mm	FFSP76SC	-
800mm	765mm 790mm	FFSP80SC	FFSP80BC
900mm	865mm 890mm	FFSP90SC	FFSP90BC
1000mm	965mm 990mm	FFSP100SC	FFSP100BC
1200mm	1165mm 1190mm	FFSP120SC	FFSP120BC

FLAIR FRAMELESS - INLINE PANELS

DESCRIPTION	CODE - SILVER	CODE - BLACK
200mm	FFIL20SC	FFIL20BC
300mm	FFIL30SC	FFIL30BC
400mm	FFIL40SC	FFIL40BC
200mm with 3 Shelves	FFILS20SC	-
300mm with 3 Shelves	FFILS30SC	-
400mm with 3 Shelves	FFILS40SC	-

FLAIR FRAMELESS - PROFILE EXTENSION

DESCRIPTION	CODE - SILVER	CODE - BLACK
10mm Compensating Wall Profile	FFCB10SC	FFCB10BG
25mm Compensating Wall Profile	FFCB25SC	FFCB25BG

6mm TOUGHENED SAFETY GLASS	1950mm HEIGHT	UP TO 50mm PRODUCT ADJUSTMENT	<input checked="" type="checkbox"/> SUITABLE FOR SIDE PANEL INSTALLATION	<input checked="" type="checkbox"/> INWARD AND OUTWARD OPENING
SUITABLE FOR WETROOM OR SHOWER TRAY INSTALLATION	UP TO 25mm WALL PROFILE EXTENSION AVAILABLE	SUITABLE FOR INSTALLATION WITH INLINE PANELS	RISING BUTT HINGE MECHANISM FOR SMOOTH MOVEMENT	SILVER & MATTE BLACK OPTIONS AVAILABLE SELECTED DOOR STYLES



FLAIR FRAMELESS SALOON DOOR

FLAIR FRAMELESS CURVED HINGED WETROOM PANEL

COLOUR OPTION: ● SILVER



FLAIR FRAMELESS
CURVED HINGED WETROOM PANEL

FLAIR FRAMELESS - CURVED HINGED WETROOM PANEL

DESCRIPTION	ADJUSTMENT SIZE		CODE - SILVER
	MIN	MAX	
900mm	875mm	900mm	FFCRR90SC

- 6mm** TOUGHENED SAFETY GLASS
- 1950mm** HEIGHT
- 25mm** PRODUCT ADJUSTMENT
- SUITABLE FOR WETROOM OR SHOWER TRAY INSTALLATION
- REVERSIBLE FOR LEFT OR RIGHT HANDED INSTALLATION
- ROTATES 180°
- 401mm** ROTATES 180°



FLAIR FRAMELESS HINGED ROTATING WETROOM PANEL



HINGED ROTATING
WETROOM PANEL (SILVER)

FLAIR FRAMELESS HINGED ROTATING WETROOM PANEL

COLOUR OPTION: ● SILVER

FLAIR FRAMELESS - HINGED ROTATING WETROOM PANEL

DESCRIPTION	ADJUSTMENT SIZE		CODE - SILVER
	MIN	MAX	
300mm	300mm	325mm	FFPD30SC
450mm	450mm	475mm	FFPD45SC
600mm	600mm	625mm	FFPD60SC

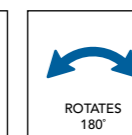
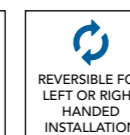
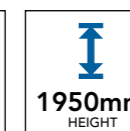

SLIMLINE CAPELLA

With minimalist design and an innovative silent roller mechanism, Slimline Capella is the perfect blend of function and form.

The unique twist and lock system enables up to 100mm wall profile adjustment on certain door styles, ensuring this range fits the most awkward of shower spaces.



CLEARVUE HYDROPHOBIC COATING RESISTS THE BUILD UP OF GRIME AND LIMESCALE ON THE GLASS SURFACE

UNIQUE EASY INSTALL PATENTED SYSTEM



WITHOUT TREATMENT



WITH TREATMENT



TWIST - ADJUST TO SUIT



LOCK - TO SECURE

KEY FEATURES

6mm
TOUGHENED SAFETY GLASS

1950mm
HEIGHT

PATENTED TWIST + LOCK ADJUSTMENT MECHANISM

INNOVATIVE SILENT WHEEL TRACK SYSTEM

CLEARVUE GLASS COATING

25mm WALL PROFILE EXTENSION AVAILABLE

REVERSIBLE FOR LEFT OR RIGHT HANDED INSTALLATION

SPARE PARTS AVAILABLE

20 YEAR GUARANTEE

SLIMLINE CAPELLA PIVOT DOOR

COLOUR OPTION: ● SILVER

SLIMLINE CAPELLA - PIVOT DOOR

DESCRIPTION	ADJUSTMENT SIZE		ACCESS	CODE - SILVER
	MIN	MAX		
800mm	700mm	800mm	422mm	STPD80SC
900mm	800mm	900mm	522mm	STPD90SC
1000mm	900mm	1000mm	622mm	STPD100SC
1200mm	1100mm	1200mm	622mm	STPD120SC

SLIMLINE CAPELLA - SEMI FRAMED SIDE PANELS

DESCRIPTION	ADJUSTMENT SIZE		CODE - SILVER
	MIN	MAX	
700mm	670mm	690mm	STSP70SC
760mm	730mm	750mm	STSP76SC
800mm	770mm	790mm	STSP80SC
900mm	870mm	890mm	STSP90SC
1000mm	970mm	990mm	STSP100SC
1100mm	1070mm	1090mm	STSP110SC
1200mm	1170mm	1190mm	STSP120SC

SLIMLINE CAPELLA - PROFILE EXTENSION

DESCRIPTION	CODE - SILVER
25mm Compensating Wall Profile	STPACKDSC



SLEEK POLISHED
CHROME HANDLES



MINIMALIST CHROME
PROFILES AND PIVOT HINGE



SLIMLINE CAPELLA
PIVOT DOOR

PIVOT DOOR IN SILVER
WITH SIDE PANEL

6mm

TOUGHENED
SAFETY GLASS

1950mm

HEIGHT

100mm

PRODUCT
ADJUSTMENT



MAGNETIC
CLOSURE



SLEEK CHROME
PLATED DOOR
HANDLES



SUITABLE FOR
SIDE PANEL
INSTALLATION

SLIMLINE CAPELLA SLIDING DOOR



SLIMLINE CAPELLA SLIDING DOOR

COLOUR OPTION: ● SILVER

SLIMLINE CAPELLA - SLIDING DOOR

DESCRIPTION	ADJUSTMENT SIZE		ACCESS	CODE - SILVER
	MIN	MAX		
1000mm	940mm	1000mm	365mm	STSA100SC
1100mm	1040mm	1100mm	428mm	STSA110SC
1200mm	1140mm	1200mm	478mm	STSA120SC
1300mm	1200mm	1300mm	528mm	STSA130SC
1400mm	1300mm	1400mm	578mm	STSA140SC
1500mm	1400mm	1500mm	628mm	STSA150SC

SLIMLINE CAPELLA - SEMI FRAMED SIDE PANELS

DESCRIPTION	ADJUSTMENT SIZE		CODE - SILVER
	MIN	MAX	
700mm	670mm	690mm	STSP70SC
760mm	730mm	750mm	STSP76SC
800mm	770mm	790mm	STSP80SC
900mm	870mm	890mm	STSP90SC
1000mm	970mm	990mm	STSP100SC
1100mm	1070mm	1090mm	STSP110SC
1200mm	1170mm	1190mm	STSP120SC

SLIMLINE CAPELLA - PROFILE EXTENSION

DESCRIPTION	CODE - SILVER
25mm Compensating Wall Profile	STPACKDSC



SLEEK POLISHED
CHROME HANDLES



QUICK RELEASE
DOUBLE ROLLERS

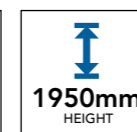

SLIDING DOOR IN
SILVER IN ALCOVE

SLIMLINE CAPELLA

CORNER ENTRY & OFFSET CORNER ENTRY

COLOUR OPTION: ● SILVER

SLIMLINE CAPELLA - CORNER ENTRY

DESCRIPTION	ADJUSTMENT SIZE		ACCESS	CODE - SILVER
	MIN	MAX		
700mm	650mm	700mm	325mm	STCE70SC
800mm	740mm	800mm	383mm	STCE80SC
900mm	840mm	900mm	454mm	STCE90SC
1000mm	940mm	1000mm	524mm	STCE100SC
1200mm	1140mm	1200mm	524mm	STCE120SC

SLIMLINE CAPELLA - OFFSET CORNER ENTRY

DESCRIPTION	ADJUSTMENT SIZE		ACCESS	CODE - SILVER
	MIN	MAX		
700 x 800mm	650-700mm	740-800mm	335mm	STCE70x80SC
700 x 900mm	650-700mm	840-900mm	370mm	STCE70x90SC
700 x 1000mm	650-700mm	940-1000mm	407mm	STCE70x100SC
700 x 1200mm	650-700mm	1140-1200mm	425mm	STCE70x120SC
800 x 900mm	740-800mm	840-900mm	405mm	STCE80x90SC
800 x 1000mm	740-800mm	940-1000mm	442mm	STCE80x100SC
800 x 1200mm	740-800mm	1140-1200mm	462mm	STCE80x120SC
900 x 1000mm	840-900mm	940-1000mm	493mm	STCE90x100SC
900 x 1200mm	840-900mm	1140-1200mm	493mm	STCE90x120SC



SLEEK POLISHED CHROME HANDLES



OFFSET CORNER ENTRY



SLIMLINE CAPELLA
CORNER ENTRY

- 6mm** TOUGHENED SAFETY GLASS
- 1950mm** HEIGHT
- UP TO **60mm** PRODUCT ADJUSTMENT
- REVERSIBLE FOR LEFT OR RIGHT HANDED INSTALLATION
- SLEEK CHROME PLATED DOOR HANDLES
- SUITABLE FOR SIDE PANEL INSTALLATION
- INNOVATIVE SILENT WHEEL TRACK SYSTEM

SLIMLINE CAPELLA BIFOLD DOOR



SLIMLINE CAPELLA BIFOLD DOOR

COLOUR OPTION: ● SILVER

SLIMLINE CAPELLA - BIFOLD DOOR

DESCRIPTION	ADJUSTMENT SIZE		ACCESS	CODE - SILVER
	MIN	MAX		
700mm	630mm	700mm	358mm	STBF70SC
800mm	730mm	800mm	428mm	STBF80SC
900mm	800mm	900mm	498mm	STBF90SC
1000mm	900mm	1000mm	578mm	STBF100SC
1100mm	1000mm	1100mm	578mm	STBF110SC
1200mm	1100mm	1200mm	578mm	STBF120SC

SLIMLINE CAPELLA - SEMI FRAMED SIDE PANELS

DESCRIPTION	ADJUSTMENT SIZE		CODE - SILVER
	MIN	MAX	
700mm	670mm	690mm	STSP70SC
760mm	730mm	750mm	STSP76SC
800mm	770mm	790mm	STSP80SC
900mm	870mm	890mm	STSP90SC
1000mm	970mm	990mm	STSP100SC
1100mm	1070mm	1090mm	STSP110SC
1200mm	1170mm	1190mm	STSP120SC

SLIMLINE CAPELLA - PROFILE EXTENSION

DESCRIPTION	CODE - SILVER
25mm Compensating Wall Profile	STPACKDSC



SLEEK POLISHED
CHROME HANDLES



BIFOLD HINGE



6mm
TOUGHENED
SAFETY GLASS

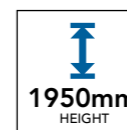

1950mm
HEIGHT



100mm
PRODUCT
ADJUSTMENT



MAGNETIC
CLOSURE



INNOVATIVE
SILENT WHEEL
TRACK SYSTEM



SLEEK CHROME
PLATED DOOR
HANDLES



SUITABLE FOR
SIDE PANEL
INSTALLATION



BIFOLD DOOR IN
SILVER WITH SIDE PANEL

SLIMLINE CAPELLA

2 DOOR QUADRANT & OFFSET QUADRANT

COLOUR OPTION: ● SILVER

SLIMLINE CAPELLA - 2 DOOR QUADRANT

DESCRIPTION	ADJUSTMENT SIZE		ACCESS	CODE - SILVER
	MIN	MAX		
800mm	750mm	800mm	370mm	STCQ80SC
900mm	850mm	900mm	514mm	STCQ90SC
1000mm	950mm	1000mm	514mm	STCQ100SC

SLIMLINE CAPELLA - 2 DOOR OFFSET QUADRANT

DESCRIPTION	ADJUSTMENT SIZE		ACCESS	CODE - SILVER
	MIN	MAX		
900 x 800mm	750-800mm	850-900mm	446mm	STCQ80x90SC
1000 x 800mm	750-800mm	950-1000mm	446mm	STCQ80x100SC
1200 x 800mm	750-800mm	1150-1200mm	460mm	STCQ80x120SC
1200 x 900mm	850-900mm	1150-1200mm	514mm	STCQ90x120SC



SLEEK POLISHED CHROME HANDLES



MINIMALIST CHROME PLATED PROFILES



SLIMLINE CAPELLA - 2 DOOR OFFSET QUADRANT



SLIMLINE CAPELLA - 2 DOOR QUADRANT

6mm

TOUGHENED SAFETY GLASS

1950mm

HEIGHT

UP TO 100mm

PRODUCT ADJUSTMENT

INNOVATIVE SILENT WHEEL TRACK SYSTEM

SLEEK CHROME PLATED DOOR HANDLES

CARA

The Cara shower door range is not just inclusively designed, it also offers the greatest standards of safety in the bathroom sector today.

Laminated glass technology is applied to each door style in the range. This means that in the unlikely event of a breakage, the glass will remain integral due to the polyvinyl butyral (PVB) interlayer.



Mosaic Tile Floor Size Warning -

Please take extra care to check adjustment sizes required for mosaic wetroom floor applications. Please contact your Flair Sales Representative for advice on mosaic floor application.



LAMINATED GLASS

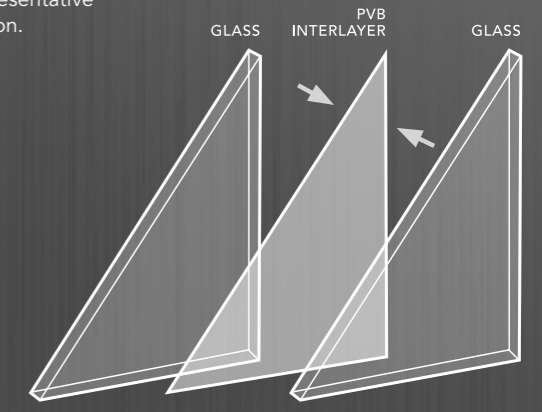

LAMINATED GLASS CONSTRUCTION WITH PVB INTERLAYER

KEY FEATURES

<p>8mm LAMINATED GLASS</p>	<p>1950mm FULL HEIGHT</p>	<p>975mm HALF HEIGHT</p>	<p>CLEARVUE GLASS COATING</p>	<p>MAGNETIC CLOSURE</p>	<p>RISING BUTT HINGE MECHANISM FOR SMOOTH MOVEMENT</p>
<p>SUITABLE FOR SHOWER TRAY OR WETROOM FLOOR INSTALLATION</p>	<p>UPTO 25mm WALL PROFILE EXTENSION AVAILABLE</p>	<p>REVERSIBLE FOR LEFT OR RIGHT HANDED INSTALLATION</p>	<p>SPARE PARTS AVAILABLE</p>	<p>10 YEAR GUARANTEE</p>	

CARA

CORNER PIVOT DOOR

COLOUR OPTION: ● SILVER

CORNER PIVOT DOOR - FULL HEIGHT

DESCRIPTION	ADJUSTMENT SIZE		ACCESS	CODE - SILVER
	MIN	MAX		
800mm - Tray Application	765mm	790mm	930mm	CACPD80SLC
900mm - Tray Application	865mm	890mm	1072mm	CACPD90SLC
1000mm - Tray Application	965mm	990mm	1212mm	CACPD100SLC
900mm - Mosaic Tile Application	900mm	925mm	1121mm	CACPD90MSLC
1000mm - Mosaic Tile Application	1000mm	1025mm	1262mm	CACPD100MSLC

SIDE PANELS - FULL HEIGHT

DESCRIPTION	ADJUSTMENT SIZE		CODE - SILVER
	MIN	MAX	
700mm	665mm	690mm	CASP70SLC
800mm	765mm	790mm	CASP80SLC
900mm	865mm	890mm	CASP90SLC
1000mm	965mm	990mm	CASPI00SLC
1200mm	1165mm	1190mm	CASPI20SLC

CORNER PIVOT DOOR - HALF HEIGHT

DESCRIPTION	ADJUSTMENT SIZE		ACCESS	CODE - SILVER
	MIN	MAX		
800mm - Tray Application	765mm	790mm	930mm	CAHCPD80SLC
900mm - Tray Application	865mm	890mm	1072mm	CAHCPD90SLC
1000mm - Tray Application	965mm	990mm	1212mm	CAHCPD100SLC
900mm - Mosaic Tile Application	900mm	925mm	980mm	CAHCPD90MSLC
1000mm - Mosaic Tile Application	1000mm	1025mm	1121mm	CAHCPD100MSLC

SIDE PANELS - HALF HEIGHT

DESCRIPTION	ADJUSTMENT SIZE		CODE - SILVER
	MIN	MAX	
700mm	665mm	690mm	CAHSP70SLC
800mm	765mm	790mm	CAHSP80SLC
900mm	865mm	890mm	CAHSP90SLC
1000mm	965mm	990mm	CAHSP100SLC
1200mm	1165mm	1190mm	CAHSP120SLC

INLINE PANELS - HALF HEIGHT

DESCRIPTION	CODE - SILVER
200mm	CAHIL20SLC
300mm	CAHIL30SLC
400mm	CAHIL40SLC

CARA - PROFILE EXTENSION

DESCRIPTION	CODE - SILVER
10mm Compensating Wall Profile with Cap Bracket	CAHCB10SC



HALF HEIGHT CORNER PIVOT DOOR



CARA
CORNER PIVOT DOOR



FULL HEIGHT CORNER PIVOT DOOR

8mm LAMINATED GLASS	1950mm FULL HEIGHT	975mm HALF HEIGHT	CLEARVUE GLASS COATING	MAGNETIC CLOSURE
INWARD AND OUTWARD OPENING	SLEEK CHROME PLATED DOOR HANDLES	REVERSIBLE FOR LEFT OR RIGHT HANDED INSTALLATION	RISEING BUTT HINGE MECHANISM FOR SMOOTH MOVEMENT	10 YEAR GUARANTEE

MOSAIC TILE FLOOR SIZE WARNING – Please take extra care to check adjustment sizes required for mosaic wetroom floor applications.

CARA CORNER BIFOLD DOOR

COLOUR OPTION: ● SILVER

8mm LAMINATED GLASS	1950mm FULL HEIGHT	975mm HALF HEIGHT	CLEARVUE GLASS COATING	MAGNETIC CLOSURE
OUTWARD OPENING ONLY	SLEEK CHROME PLATED DOOR HANDLES	REVERSIBLE FOR LEFT OR RIGHT HANDED INSTALLATION	RISEING BUTT HINGE MECHANISM FOR SMOOTH MOVEMENT	10 YEAR GUARANTEE



CORNER BIFOLD DOOR - FULL HEIGHT

DESCRIPTION	ADJUSTMENT SIZE		ACCESS	CODE - SILVER
	MIN	MAX		
900mm - Tray Application	865mm	890mm	970mm	CACBF90SLC
1000mm - Tray Application	965mm	990mm	1095mm	CACBF100SLC
900mm - Mosaic Tile Application	900mm	925mm	1015mm	CACBF90MSLC
1000mm - Mosaic Tile Application	1000mm	1025mm	1145mm	CACBF100MSLC

SIDE PANELS - FULL HEIGHT

DESCRIPTION	ADJUSTMENT SIZE		CODE - SILVER
	MIN	MAX	
700mm	665mm	690mm	CASP70SLC
800mm	765mm	790mm	CASP80SLC
900mm	865mm	890mm	CASP90SLC
1000mm	965mm	990mm	CASP100SLC
1200mm	1165mm	1190mm	CASP120SLC

CORNER BIFOLD DOOR - HALF HEIGHT

DESCRIPTION	ADJUSTMENT SIZE		ACCESS	CODE - SILVER
	MIN	MAX		
900mm - Tray Application	865mm	890mm	970mm	CAHCBF90SLC
1000mm - Tray Application	965mm	990mm	1095mm	CAHCBF100SLC
900mm - Mosaic Tile Application	900mm	925mm	1015mm	CAHCBF90MSLC
1000mm - Mosaic Tile Application	1000mm	1025mm	1145mm	CAHCBF100MSLC

SIDE PANELS - HALF HEIGHT

DESCRIPTION	ADJUSTMENT SIZE		CODE - SILVER
	MIN	MAX	
700mm	665mm	690mm	CAHSP70SLC
800mm	765mm	790mm	CAHSP80SLC
900mm	865mm	890mm	CAHSP90SLC
1000mm	965mm	990mm	CAHSP100SLC
1200mm	1165mm	1190mm	CAHSP120SLC

INLINE PANELS - HALF HEIGHT

DESCRIPTION	CODE - SILVER
200mm	CAHIL20SLC
300mm	CAHIL30SLC
400mm	CAHIL40SLC

CARA - PROFILE EXTENSION

DESCRIPTION	CODE - SILVER
10mm Compensating Wall Profile with Cap Bracket	CAHCB10SC

MOSAIC TILE FLOOR SIZE WARNING – Please take extra care to check adjustment sizes required for mosaic wetroom floor applications.

CARA CORNER BIFOLD DOOR



CARA BIFOLD DOOR

COLOUR OPTION: ● SILVER

BIFOLD DOOR - FULL HEIGHT

DESCRIPTION	ADJUSTMENT SIZE		ACCESS	CODE - SILVER
	MIN	MAX		
900mm	850mm	900mm	640mm	CABF90SLC

SIDE PANELS - FULL HEIGHT

DESCRIPTION	ADJUSTMENT SIZE		CODE - SILVER
	MIN	MAX	
700mm	665mm	690mm	CASP70SLC
800mm	765mm	790mm	CASP80SLC
900mm	865mm	890mm	CASP90SLC
1000mm	965mm	990mm	CASP100SLC
1200mm	1165mm	1190mm	CASP120SLC

BIFOLD DOOR - HALF HEIGHT

DESCRIPTION	ADJUSTMENT SIZE		ACCESS	CODE - SILVER
	MIN	MAX		
900mm	850mm	900mm	605mm	CAHBF90SLC

SIDE PANELS - HALF HEIGHT

DESCRIPTION	ADJUSTMENT SIZE		CODE - SILVER
	MIN	MAX	
700mm	665mm	690mm	CAHSP70SLC
800mm	765mm	790mm	CAHSP80SLC
900mm	865mm	890mm	CAHSP90SLC
1000mm	965mm	990mm	CAHSP100SLC
1200mm	1165mm	1190mm	CAHSP120SLC

INLINE PANELS - HALF HEIGHT

DESCRIPTION	CODE - SILVER
200mm	CAHIL20SLC
300mm	CAHIL30SLC
400mm	CAHIL40SLC

CARA - PROFILE EXTENSION

DESCRIPTION	CODE - SILVER
10mm Compensating Wall Profile with Cap Bracket	CAHCB10SC

MOSAIC TILE FLOOR SIZE WARNING

Please take extra care to check adjustment sizes required for mosaic wetroom floor applications.



FULL HEIGHT
BIFOLD DOOR



HALF HEIGHT
BIFOLD DOOR



CARA
BIFOLD DOOR

8mm LAMINATED GLASS	1950mm FULL HEIGHT	975mm HALF HEIGHT	CLEARVUE GLASS COATING	MAGNETIC CLOSURE
OUTWARD OPENING ONLY	SLEEK CHROME PLATED DOOR HANDLES	REVERSIBLE FOR LEFT OR RIGHT HANDED INSTALLATION	RISING BUTT HINGE MECHANISM FOR SMOOTH MOVEMENT	10 YEAR GUARANTEE

CARA SPLIT PIVOT DOOR

COLOUR OPTION: ● SILVER



HALF HEIGHT
SPLIT PIVOT DOOR

SPLIT PIVOT DOOR - FULL HEIGHT

DESCRIPTION	ADJUSTMENT SIZE		ACCESS	CODE - SILVER
	MIN	MAX		
900mm	850mm	900mm	714mm	CASPD90SLC

SIDE PANELS - FULL HEIGHT

DESCRIPTION	ADJUSTMENT SIZE		CODE - SILVER
	MIN	MAX	
700mm	665mm	690mm	CASP70SLC
800mm	765mm	790mm	CASP80SLC
900mm	865mm	890mm	CASP90SLC
1000mm	965mm	990mm	CASPI00SLC
1200mm	1165mm	1190mm	CASPI20SLC

SPLIT PIVOT DOOR - HALF HEIGHT

DESCRIPTION	ADJUSTMENT SIZE		ACCESS	CODE - SILVER
	MIN	MAX		
900mm	850mm	900mm	710mm	CAHSPD90SLC

SIDE PANELS - HALF HEIGHT









DESCRIPTION	ADJUSTMENT SIZE		CODE - SILVER
	MIN	MAX	
700mm	665mm	690mm	CAHSP70SLC
800mm	765mm	790mm	CAHSP80SLC
900mm	865mm	890mm	CAHSP90SLC
1000mm	965mm	990mm	CAHSP100SLC
1200mm	1165mm	1190mm	CAHSP120SLC

INLINE PANELS - HALF HEIGHT

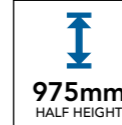
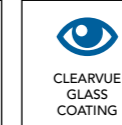
DESCRIPTION	CODE - SILVER
200mm	CAHIL20SLC
300mm	CAHIL30SLC
400mm	CAHIL40SLC

CARA - PROFILE EXTENSION

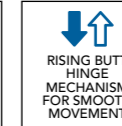
DESCRIPTION	CODE - SILVER
10mm Compensating Wall Profile with Cap Bracket	CAHCB10SC

 8mm LAMINATED GLASS	 1950mm FULL HEIGHT	 975mm HALF HEIGHT	 CLEARVUE GLASS COATING	 MAGNETIC CLOSURE
 OUTWARD OPENING ONLY	 SLEEK CHROME PLATED DOOR HANDLES	 REVERSIBLE FOR LEFT OR RIGHT HANDED INSTALLATION	 RISING BUTT HINGE MECHANISM FOR SMOOTH MOVEMENT	 10 YEAR GUARANTEE

MOSAIC TILE FLOOR SIZE WARNING – Please take extra care to check adjustment sizes required for mosaic wetroom floor applications.

CARA
SPLIT PIVOT DOOR

FULL HEIGHT
SPLIT PIVOT DOOR



CARA SALOON DOOR

COLOUR OPTION: ● SILVER

SALOON DOOR - FULL HEIGHT

DESCRIPTION	ADJUSTMENT SIZE		ACCESS	CODE - SILVER
	MIN	MAX		
900mm	850mm	900mm	685mm	CASD90SLC

SIDE PANELS - FULL HEIGHT

DESCRIPTION	ADJUSTMENT SIZE		CODE - SILVER
	MIN	MAX	
700mm	665mm	690mm	CASP70SLC
800mm	765mm	790mm	CASP80SLC
900mm	865mm	890mm	CASP90SLC
1000mm	965mm	990mm	CASPI00SLC
1200mm	1165mm	1190mm	CASPI20SLC

SALOON DOOR - HALF HEIGHT

DESCRIPTION	ADJUSTMENT SIZE		ACCESS	CODE - SILVER
	MIN	MAX		
900mm	850mm	900mm	685mm	CAHSD90SLC

SIDE PANELS - HALF HEIGHT

DESCRIPTION	ADJUSTMENT SIZE		CODE - SILVER
	MIN	MAX	
700mm	665mm	690mm	CAHSP70SLC
800mm	765mm	790mm	CAHSP80SLC
900mm	865mm	890mm	CAHSP90SLC
1000mm	965mm	990mm	CAHSP100SLC
1200mm	1165mm	1190mm	CAHSP120SLC

INLINE PANELS - HALF HEIGHT

DESCRIPTION	CODE - SILVER
200mm	CAHIL20SLC
300mm	CAHIL30SLC
400mm	CAHIL40SLC

CARA - PROFILE EXTENSION

DESCRIPTION	CODE - SILVER
10mm Compensating Wall Profile with Cap Bracket	CAHCB10SC

MOSAIC TILE FLOOR SIZE WARNING

Please take extra care to check adjustment sizes required for mosaic wetroom floor applications.



HALF HEIGHT
SALOON DOOR



FULL HEIGHT
SALOON DOOR
SHOWN WITH
SIDE PANEL



CARA
SALOON DOOR

8mm LAMINATED GLASS	1950mm FULL HEIGHT	975mm HALF HEIGHT	CLEARVUE GLASS COATING	MAGNETIC CLOSURE
INWARD AND OUTWARD OPENING	SLEEK CHROME PLATED DOOR HANDLES	REVERSIBLE FOR LEFT OR RIGHT HANDED INSTALLATION	RISING BUTT HINGE MECHANISM FOR SMOOTH MOVEMENT	10 YEAR GUARANTEE



SOUL

PREMIUM GRAB BAR COLLECTION

A stylish collection of chrome plated stainless steel grab bars to complement your bathroom.



BLACK RUBBER GRIP OPTION

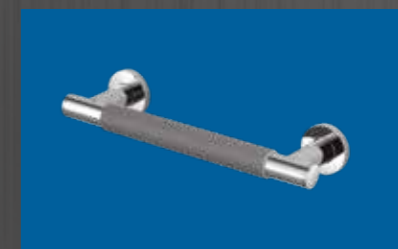

GREY RUBBER GRIP OPTION

KEY FEATURES



S304
STAINLESS STEEL



200KG
LOAD TEST



25MM OR 32MM
BAR DIAMETER

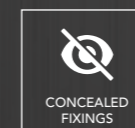

CONCEALED
FIXINGS

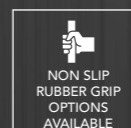

NON SLIP
RUBBER GRIP
OPTIONS
AVAILABLE



S304 STAINLESS
STEEL SCREWS
INCLUDED

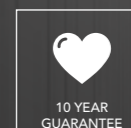

10 YEAR
GUARANTEE

CHROME GRAB BAR 30cm

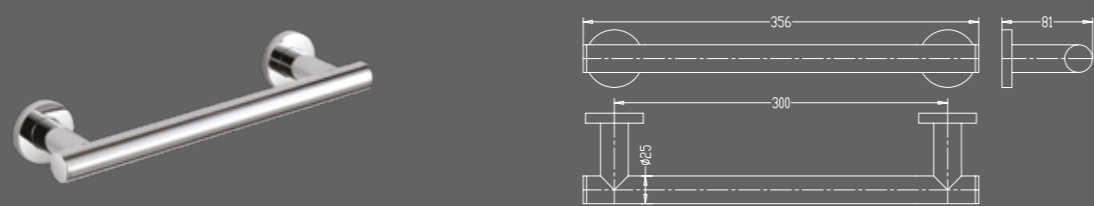

CHROME GRAB BAR 45cm

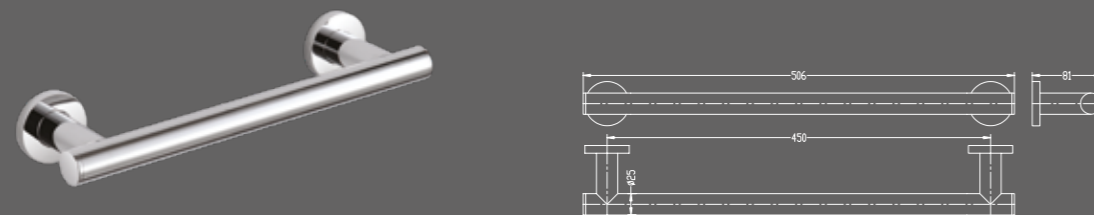

CHROME GRAB BAR 60cm

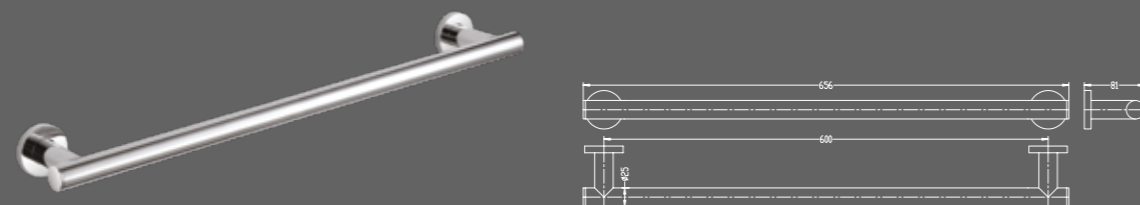

25MM DIAMETER CHROME GRAB BARS

DESCRIPTION	CODE - CHROME
Grab Bar 30cm	SOGBS30S
Grab Bar 45cm	SOGBS45S
Grab Bar 60cm	SOGBS60S

32MM DIAMETER CHROME GRAB BARS

DESCRIPTION	CODE - CHROME
Grab Bar 30cm	SOGB32S30S
Grab Bar 45cm	SOGB32S45S
Grab Bar 60cm	SOGB32S60S

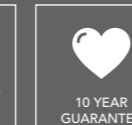
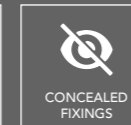

STRAIGHT GRAB BARS

WITH RUBBER GRIP OPTION (25MM DIAMETER)

CHROME GRAB BAR 30cm – with Choice of Black or Grey Rubber Grip

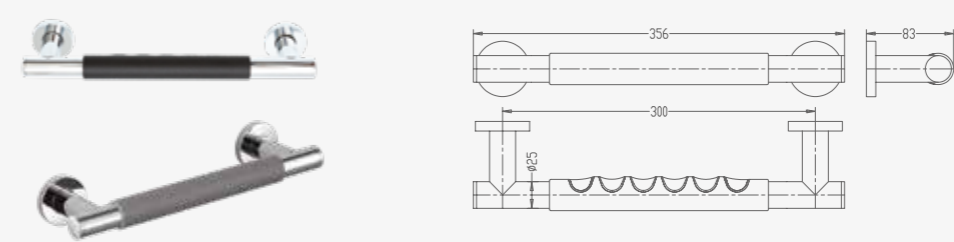

CHROME GRAB BAR 45cm – with Choice of Black or Grey Rubber Grip

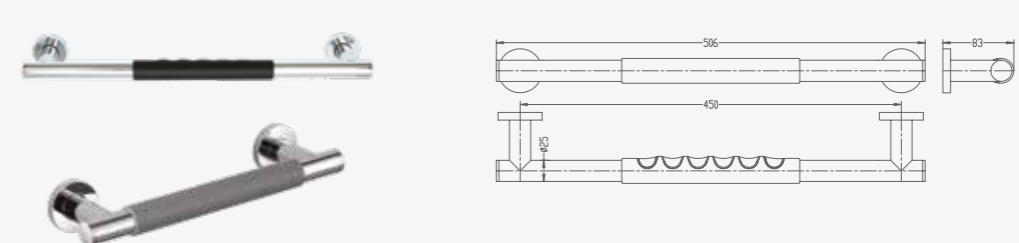

CHROME GRAB BAR 60cm – with Choice of Black or Grey Rubber Grip

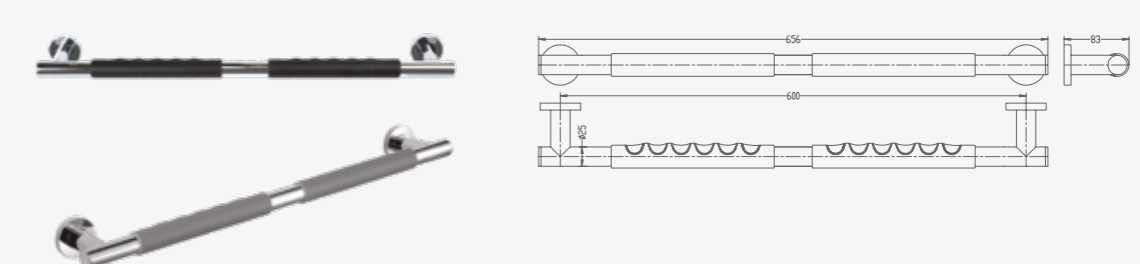

DESCRIPTION	CODE - CHROME
Grab Bar 30cm – with Black Rubber Grip	SOGBS30SB
Grab Bar 30cm – with Grey Rubber Grip	SOGBS30SG
Grab Bar 45cm – with Black Rubber Grip	SOGBS45SB
Grab Bar 45cm – with Grey Rubber Grip	SOGBS45SG
Grab Bar 60cm – with Black Rubber Grip	SOGBS60SB
Grab Bar 60cm – with Grey Rubber Grip	SOGBS60SG

SOUL

135° ANGLED BARS - CHROME PLATED STAINLESS STEEL

LEFT HAND

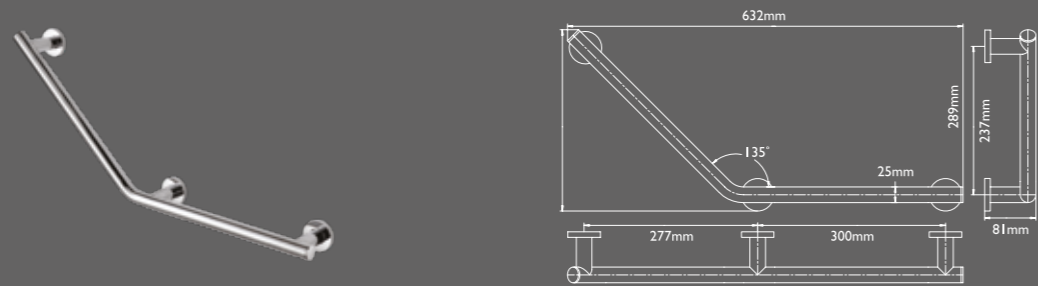

RIGHT HAND

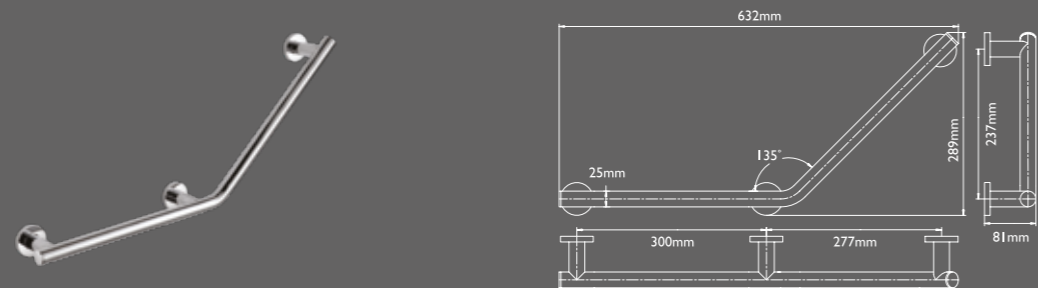

UNIVERSAL WITH BASKET - SUITS LEFT OR RIGHT HAND APPLICATION

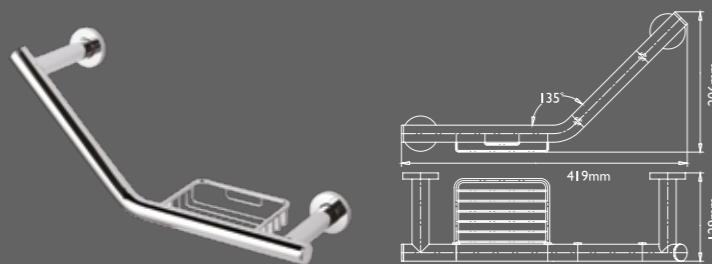

25MM DIAMETER 135° ANGLED GRAB BARS

DESCRIPTION	CODE - CHROME
135° Grab Bar - Left Hand	SOGB135LS
135° Grab Bar - Right Hand	SOGB135RS
135° Grab Bar - Universal With Basket	SOGBABS

25MM DIAMETER 135° ANGLED GRAB BARS

DESCRIPTION	CODE - CHROME
135° Angled Grab Bar (32mm diameter)	SOGB32135S

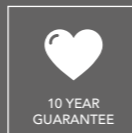
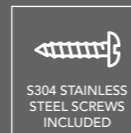
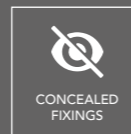

135° ANGLED BARS

WITH RUBBER GRIP OPTION (25MM DIAMETER)

LEFT HAND – with Black Rubber Grip



RIGHT HAND – with Black Rubber Grip



LEFT HAND – with Grey Rubber Grip



RIGHT HAND – with Grey Rubber Grip

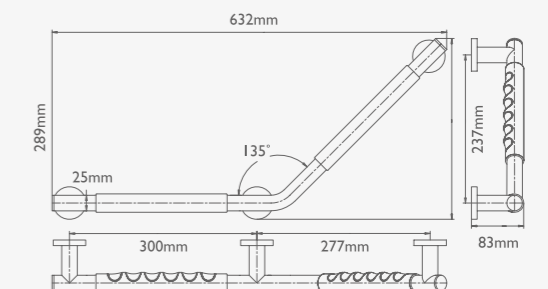
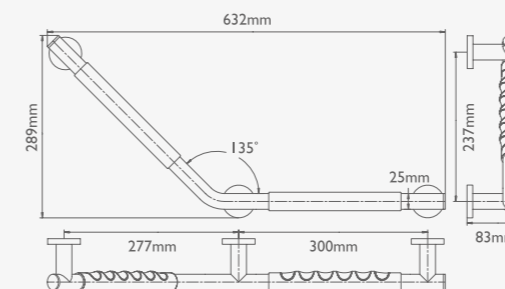

DESCRIPTION	CODE - CHROME
135° Grab Bar – Left Hand with Black Rubber Grip	SOGB135LSB
135° Grab Bar – Right Hand with Black Rubber Grip	SOGB135RSB
135° Grab Bar – Left Hand with Grey Rubber Grip	SOGB135LSG
135° Grab Bar – Right Hand with Grey Rubber Grip	SOGB135RSG

SOUL

90° ANGLED BARS - CHROME PLATED STAINLESS STEEL

LEFT HAND

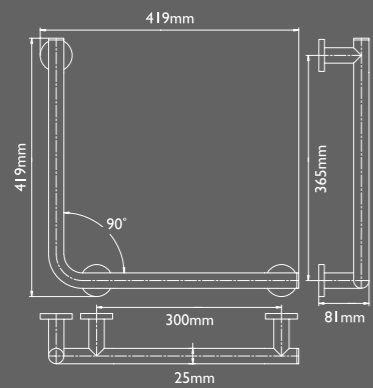

RIGHT HAND

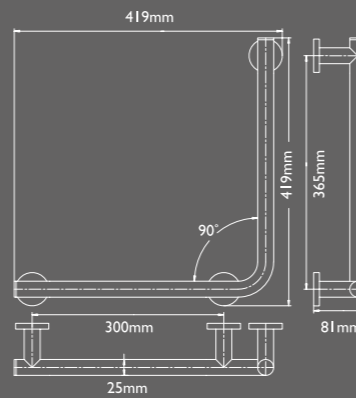

S304
STAINLESS STEEL



200KG
LOAD TEST



25mm OR 32mm
BAR DIAMETER



CONCEALED
FIXINGS



NON SLIP
RUBBER GRIP
OPTIONS
AVAILABLE



S304 STAINLESS
STEEL SCREWS
INCLUDED



10 YEAR
GUARANTEE

25MM DIAMETER 90° ANGLED GRAB BARS

DESCRIPTION CODE - CHROME

90° Grab Bar - Left Hand (32mm Diameter) SOGB90LS

90° Grab Bar - Right Hand (32mm Diameter) SOGB90RS

25MM DIAMETER 90° ANGLED GRAB BARS

DESCRIPTION CODE - CHROME

90° Grab Bar - Left Hand (32mm Diameter) SOGB3290LS

90° Grab Bar - Right Hand (32mm Diameter) SOGB3290RS

90° ANGLED BARS

WITH RUBBER GRIP OPTION (25MM DIAMETER)

LEFT HAND

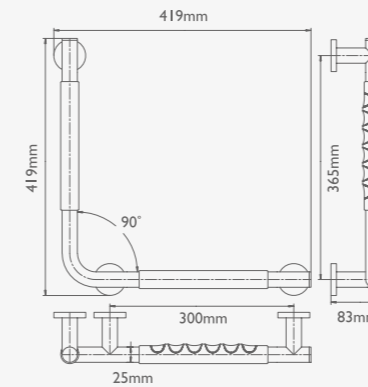

RIGHT HAND

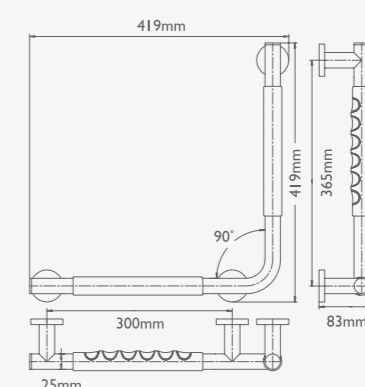

DESCRIPTION CODE - CHROME

90° Grab Bar - Left Hand with Black Rubber Grip SOGB90LSB

90° Grab Bar - Right Hand with Grey Rubber Grip SOGB90RSB

90° Grab Bar - Left Hand with Black Rubber Grip SOGB90LSG

90° Grab Bar - Right Hand with Grey Rubber Grip SOGB90RSG

TRAYS

Extensive selection of shower tray shapes and sizes to complement your bathroom.

SHOWER TRAY INSTALLATION

All shower trays must be installed as per instructions supplied. Install on a base of fine sand, cement and cement additive. Please note: Silicone sealants, foams, mastics, installation compound adhesive or similar must not be used as a substitute for cement. Ensure shower tray is 100% level and water test to ensure water is draining correctly. If not satisfied at any stage do not proceed with fitting. Fitting of Shower Tray is acceptance of quality.

KEY FEATURES

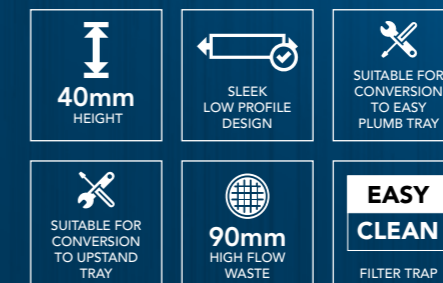

SLIMLINE SHOWER TRAYS

Extensive selection of shower tray shapes and sizes to complement your bathroom.

- Strong and rigid construction
- Manufactured to British Standard BS6340/5
- Tough high gloss ABS acrylic capped surface finish
- Easy-to-clean and maintain

SHOWER TRAY INSTALLATION
All shower trays must be installed as per instructions supplied. Please note: Silicone sealants, foams, mastics, installation compound adhesive etc. must not be used as a substitute for cement. Ensure shower tray is installed 100% level and water test to ensure it is draining correctly. Fitting of Shower Tray is acceptance of quality.



40mm
HEIGHT



SLEEK
LOW PROFILE
DESIGN



90mm
HIGH FLOW
WASTE

**EASY
CLEAN**

FILTER TRAP

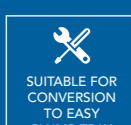

SUITABLE FOR
CONVERSION
TO EASY
PLUMB TRAY

SLIMLINE - RECTANGLE TRAY

SIZE	CODE
800 x 700mm	TSL8070R
900 x 700mm	TSL9070R
900 x 760mm	TSL9076R
900 x 800mm	TSL9080R
1000 x 700mm	TSL10070R
1000 x 760mm	TSL10076R
1000 x 800mm	TSL10080R
1000 x 900mm	TSL10090R
1100 x 700mm	TSL11070R
1100 x 760mm	TSL11076R
1100 x 800mm	TSL11080R
1100 x 900mm	TSL11090R
1200 x 700mm	TSL12070R
1200 x 760mm	TSL12076R
1200 x 800mm	TSL12080R
1200 x 900mm	TSL12090R
1200 x 1000mm	TSL120100R
1300 x 800mm	TSL13080R
1300 x 900mm	TSL13090R
1400 x 700mm	TSL14070R
1400 x 760mm	TSL14076R
1400 x 800mm	TSL14080R
1400 x 900mm	TSL14090R
1500 x 700mm	TSL15070R
1500 x 760mm	TSL15076R
1500 x 800mm	TSL15080R
1500 x 900mm	TSL15090R
1600 x 700mm	TSL16070R
1600 x 800mm	TSL16080R
1600 x 900mm	TSL16090R
1700 x 700mm	TSL17070R
1700 x 750mm	TSL17075R
1700 x 800mm	TSL17080R
1700 x 900mm	TSL17090R
1800 x 800mm	TSL18080R
1800 x 900mm	TSL18090R
2000 x 900mm	TSL20090R



NOTE: It is normal for a small amount of localized water to be retained on a shower tray surface after use. This should be wiped dry to prevent any build up of residue.

SLIMLINE - SQUARE TRAY

SIZE	CODE
700 x 700mm	TSL70S
760 x 760mm	TSL76S
800 x 800mm	TSL80S
900 x 900mm	TSL90S
1000 x 1000mm	TSL100S
1200 x 1200mm	TSL120S

SLIMLINE - QUADRANT TRAY

SIZE	CODE
800 x 800mm	TSL80Q
900 x 900mm	TSL90Q
1000 x 1000mm	TSL100Q

SLIMLINE - OFFSET QUADRANT TRAY

SIZE	CODE
900 x 800mm - Left Hand	TSL9080LOQ
900 x 800mm - Right Hand	TSL9080ROQ
1000 x 800mm - Left Hand	TSL10080LOQ
1000 x 800mm - Right Hand	TSL10080ROQ
1000 x 900mm - Left Hand	TSL10090LOQ
1000 x 900mm - Right Hand	TSL10090ROQ
1100 x 800mm - Left Hand	TSL11080LOQ
1100 x 800mm - Right Hand	TSL11080ROQ
1100 x 900mm - Left Hand	TSL11090LOQ
1100 x 900mm - Right Hand	TSL11090ROQ
1200 x 800mm - Left Hand	TSL12080LOQ
1200 x 800mm - Right Hand	TSL12080ROQ
1200 x 900mm - Left Hand	TSL12090LOQ
1200 x 900mm - Right Hand	TSL12090ROQ



SLIMLINE RECTANGLE TRAY INCLUDING SHOWER WASTE



SLIMLINE SQUARE TRAY INCLUDING SHOWER WASTE



SLIMLINE QUADRANT TRAY INCLUDING SHOWER WASTE



SLIMLINE OFFSET QUADRANT TRAY INCLUDING SHOWER WASTE (right hand illustrated)

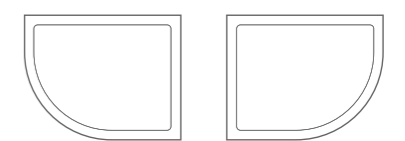

OFFSET QUADRANT LEFT HAND

OFFSET QUADRANT RIGHT HAND

ANTI-SLIP SHOWER TRAYS

NOTE: It is normal for a small amount of localized water to be retained on a shower tray surface after use. This should be wiped dry to prevent any build up of residue.

ANTI-SLIP SLIMLINE - RECTANGLE TRAY

SIZE	CODE
1000 x 800mm	ASTSLI0080R
1000 x 900mm	ASTSLI0090R
1100 x 800mm	ASTSLI1080R
1100 x 900mm	ASTSLI1090R
1200 x 700mm	ASTSLI2070R
1200 x 760mm	ASTSLI2076R
1200 x 800mm	ASTSLI2080R
1200 x 900mm	ASTSLI2090R
1400 x 700mm	ASTSLI4070R
1400 x 800mm	ASTSLI4080R
1400 x 900mm	ASTSLI4090R
1500 x 700mm	ASTSLI5070R
1500 x 800mm	ASTSLI5080R
1500 x 900mm	ASTSLI5090R
1600 x 700mm	ASTSLI6070R
1600 x 800mm	ASTSLI6080R
1600 x 900mm	ASTSLI6090R
1700 x 700mm	ASTSLI7070R
1700 x 800mm	ASTSLI7080R
1700 x 900mm	ASTSLI7090R

- Anti-slip coating for extra safety in the showering space
- Pendulum slip tested, in accordance with British Standard BS7976:2
- Classified as low slip potential



SHOWER TRAY INSTALLATION
All shower trays must be installed as per instructions supplied. Please note: Silicone sealants, foams, mastics, installation compound adhesive etc. must not be used as a substitute for cement. Ensure shower tray is installed 100% level and water test to ensure it is draining correctly. Fitting of Shower Tray is acceptance of quality.

ANTI-SLIP SLIMLINE - OFFSET QUADRANT TRAY

PRODUCT DESCRIPTION	CODE
1000 x 800mm - Left Hand	ASTSLI0080LOQ
1000 x 800mm - Right Hand	ASTSLI0080ROQ
1000 x 900mm - Left Hand	ASTSLI0090LOQ
1000 x 900mm - Right Hand	ASTSLI0090ROQ
1200 x 800mm - Left Hand	ASTSLI2080LOQ
1200 x 800mm - Right Hand	ASTSLI2080ROQ
1200 x 900mm - Left Hand	ASTSLI2090LOQ
1200 x 900mm - Right Hand	ASTSLI2090ROQ

ANTI-SLIP SLIMLINE - TRAYS WITH CORNER WASTE

PRODUCT DESCRIPTION	CODE
900 x 900mm - Quadrant Tray - Inc. Corner Waste	CASTSL90Q
1000 x 1000mm Quadrant Tray - Inc. Corner Waste	CASTSL100Q
900 x 900mm - Square Tray - Inc. Corner Waste	CASTSL90S
1000 x 1000mm - Square Tray - Inc. Corner Waste	CASTSL100S
1000 x 800mm - Rectangle Tray - Inc. Corner Waste	CASTSLI0080R
1200 x 800mm - Rectangle Tray - Inc. Corner Waste	CASTSLI2080R
1200 x 900mm - Rectangle Tray - Inc. Corner Waste	CASTSLI2090R

ANTI-SLIP SLIMLINE - SQUARE TRAY

SIZE	CODE
800 x 800mm	ASTSL80S
900 x 900mm	ASTSL90S
1000 x 1000mm	ASTSL100S

ANTI-SLIP SLIMLINE - QUADRANT TRAY

SIZE	CODE
800 x 800mm	ASTSL80Q
900 x 900mm	ASTSL90Q
1000 x 1000mm	ASTSL100Q

- 40mm HEIGHT
- ANTI SLIP SURFACE
- 90mm HIGH FLOW WASTE
- EASY CLEAN FILTER TRAP
- SUITABLE FOR CONVERSION TO EASY PLUMB TRAY
- SLEEK LOW PROFILE DESIGN



RECTANGLE TRAY CORNER WASTE



SQUARE TRAY CORNER WASTE



900mm QUADRANT TRAY CORNER WASTE



800mm QUADRANT TRAY CORNER WASTE

25MM ULTRA SLIM SHOWER TRAYS

25MM ANTI-SLIP ULTRA SLIM SHOWER TRAYS

ULTRA SLIM - RECTANGLE TRAY

SIZE	CODE
1000 x 800mm - Inc. Waste & White Grill	USLI0080R
1000 x 900mm - Inc. Waste & White Grill	USLI0090R
1200 x 800mm - Inc. Waste & White Grill	USLI2080R
1200 x 900mm - Inc. Waste & White Grill	USLI2090R
1400 x 800mm - Inc. Waste & White Grill	USLI4080R
1400 x 900mm - Inc. Waste & White Grill	USLI4090R
1500 x 800mm - Inc. Waste & White Grill	USLI5080R
1500 x 900mm - Inc. Waste & White Grill	USLI5090R
1600 x 800mm - Inc. Waste & White Grill	USLI6080R
1600 x 900mm - Inc. Waste & White Grill	USLI6090R
1700 x 800mm - Inc. Waste & White Grill	USLI7080R
1700 x 900mm - Inc. Waste & White Grill	USLI7090R
1800 x 800mm - Inc. Waste & White Grill	USLI8080R
1800 x 900mm - Inc. Waste & White Grill	USLI8090R

ULTRA SLIM - SQUARE TRAY

SIZE	CODE
800 x 800mm - Inc. Waste & White Grill	USL80S
900 x 900mm - Inc. Waste & White Grill	USL90S

ULTRA SLIM - QUADRANT & OFFSET QUADRANT TRAY

SIZE	CODE
800 x 800mm	USL80Q
900 x 900mm	USL90Q
1000 x 800mm Left Hand - Inc. Waste & White Grill	USLI0080LOQ
1000 x 800mm Right Hand - Inc. Waste & White Grill	USLI0080ROQ
1200 x 800mm Left Hand - Inc. Waste & White Grill	USLI2080LOQ
1200 x 800mm Right Hand - Inc. Waste & White Grill	USLI2080ROQ
1200 x 900mm Left Hand - Inc. Waste & White Grill	USLI2090LOQ
1200 x 900mm Right Hand - Inc. Waste & White Grill	USLI2090ROQ

ANTI-SLIP ULTRA SLIM - RECTANGLE TRAY

SIZE	CODE
1000 x 800mm - Inc. Waste & White Grill	AUSLI0080R
1200 x 800mm - Inc. Waste & White Grill	AUSLI2080R
1200 x 900mm - Inc. Waste & White Grill	AUSLI2090R
1400 x 800mm - Inc. Waste & White Grill	AUSLI4080R
1400 x 900mm - Inc. Waste & White Grill	AUSLI4090R
1500 x 800mm - Inc. Waste & White Grill	AUSLI5080R
1600 x 800mm - Inc. Waste & White Grill	AUSLI6080R
1600 x 900mm - Inc. Waste & White Grill	AUSLI6090R
1700 x 800mm - Inc. Waste & White Grill	AUSLI7080R
1700 x 900mm - Inc. Waste & White Grill	AUSLI7090R

ANTI-SLIP ULTRA SLIM - SQUARE TRAY

SIZE	CODE
900 x 900mm - Inc. Waste & White Grill	AUSL90S



ULTRA SLIM RECTANGLE TRAY INCLUDING WASTE AND WHITE GRILL



ULTRA SLIM SQUARE TRAY INCLUDING WASTE AND WHITE GRILL



ULTRA SLIM QUADRANT TRAY INCLUDING WASTE AND WHITE GRILL



ULTRA SLIM OFFSET QUADRANT TRAY - RH PICTURED INCLUDING WASTE AND WHITE GRILL

SLIMLINE SHOWER TRAYS WITH TILING UPSTAND

SLIMLINE - SQUARE TRAY WITH UPSTAND

SIZE	CODE
760 x 760mm - Inc. Waste	TSL76SU
800 x 800mm - Inc. Waste	TSL80SU
900 x 900mm - Inc. Waste	TSL90SU

SLIMLINE - RECTANGLE TRAY WITH UPSTAND

SIZE	CODE
900 x 760mm - Inc. Waste	TSL9076RU
1000 x 760mm - Inc. Waste	TSL10076RU
1000 x 800mm - Inc. Waste	TSL10080RU
1200 x 760mm - Inc. Waste	TSL12076RU
1200 x 800mm - Inc. Waste	TSL12080RU
1200 x 900mm - Inc. Waste	TSL12090RU
1400 x 800mm - Inc. Waste	TSL14080RU
1400 x 900mm - Inc. Waste	TSL14090RU
1700 x 750mm - Inc. Waste	TSL17075RU

SLIMLINE - QUADRANT TRAY WITH UPSTAND

SIZE	CODE
800 x 800mm - Inc. Waste	TSL80QU
900 x 900mm - Inc. Waste	TSL90QU

SLIMLINE - TRAYS WITH CORNER WASTE

SIZE	CODE
800 x 800mm - Quadrant Tray - Inc. Corner Waste	CTSL80Q
900 x 900mm - Quadrant Tray - Inc. Corner Waste	CTSL90Q
1000 x 1000mm - Quadrant Tray - Inc. Corner Waste	CTSL100Q
800 x 800mm - Square Tray - Inc. Corner Waste	CTSL80S
900 x 900mm - Square Tray - Inc. Corner Waste	CTSL90S
1000 x 1000mm - Square Tray - Inc. Corner Waste	CTSL100S
900 x 800mm - Rectangle Tray - Inc. Corner Waste	CTSL9080R
1000 x 800mm - Rectangle Tray - Inc. Corner Waste	CTSL10080R
1200 x 800mm - Rectangle Tray - Inc. Corner Waste	CTSL12080R
1200 x 900mm - Rectangle Tray - Inc. Corner Waste	CTSL12090R

EASY PLUMB KIT - SUITS ALL SLIMLINE SHOWER TRAYS



Slimline easy plumb shower kits have adjustable legs to comply with building regulations to assist in installation and for maintenance of waste outlets if required after building settlement. The slimline easy plumb kit provides this access without compromising on style in the bathroom. An easy plumb tray can be made by using any of the Flair slimline trays and a kit. This will increase the height of the tray by 95mm. Accessories are not to scale - for visual representation only.

DESCRIPTION	WEIGHT	CODE
Easy Plumb Riser Kit For All Square Trays & Rectangle Trays (Suitable for maximum tray size of 1200mm)	2kg	WD3
Easy Plumb Riser Kit For All Quadrant Trays (Suitable for maximum tray size of 1200 x 900mm)	3kg	WD4
Easy Plumb Riser Kit For All Square Trays & Rectangle Trays (Suitable for maximum tray size of 2000mm)	2kg	WD5

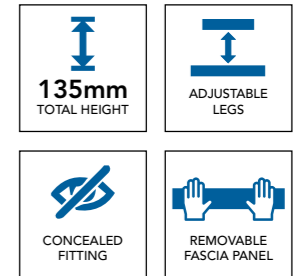

WASTES

SHOWER WASTES - 90MM

PRODUCT DESCRIPTION	COLOUR	CODE
Shower Waste with Plastic Dome	White	ST90WH10-70
Shower Waste with Plastic Dome	Matte Black	ST90MB10-70
Tourbillon Shower Trap & Waste	Chrome	WIR30120662



PROSEAL WATERPROOF BARRIER SEAL

Flexible up-stand seal installed onto shower trays, baths and worktops eliminating the risk of water leakage.

PROSEAL

PRODUCT DESCRIPTION	CODE
ProSeal 2 metre Roll	PROS2.0M
ProSeal 2.5 metre Roll	PROS2.5M
ProSeal 3 metre Roll	PROS3.0M
ProSeal 3.5 metre Roll	PROS3.5M
ProSeal 4 metre Roll	PROS4.0M
ProSeal 10 metre Roll	PROS10.0M
ProSeal 20 metre Roll	PROS20.0M

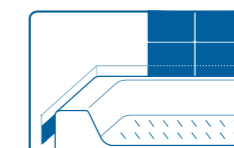

SHOWER TRAY SHAPES

FIND YOUR PERFECT FIT



SQUARE



RECTANGLE



QUADRANT



OFFSET QUADRANT LEFT HAND



OFFSET QUADRANT RIGHT HAND

SHOWER DOOR STYLES

DESIGNED TO FIT YOUR SPACE



SLIDING DOOR



CORNER ENTRY



OFFSET QUADRANT



PIVOT DOOR



QUADRANT



BIFOLD DOOR

AT A GLANCE METRIC CONVERTER

NOMINAL GUIDE ONLY

METRIC (MM)	FEET (FT)	INCHES (INS)
700	2 ft 3.5	27.5
760	2 ft 6.0	30
800	2 ft 7.5	31.5
900	2 ft 11.4	35.5
1000	3 ft 3.5	39.5
1100	3 ft 7.3	43.3
1200	3 ft 11.2	47.2

SHOWER DOOR MEASURING GUIDE

Note: Your measurements should be taken after tray installation and tiling.
The space left after tiling will determine the shower door size required.

FOR A RECESS

Measurement at low point _____

Measurement at high point _____

* Two measures relevant for uneven walls to ensure shower door caters for adjustment width needed

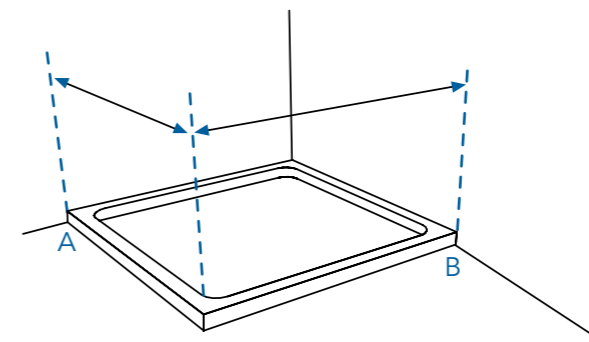
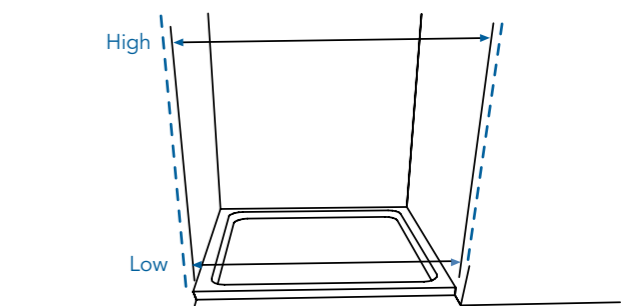

FOR A CORNER

Measure to acute edge of shower tray

Measurement A _____ B _____

FOR A QUADRANT*

Radius Guide	
Distance 'C' (mm)	Radius (mm)
207	500
218	525
228	550

*All Flair Quadrant and Offset Quadrant trays have a 550mm radius.

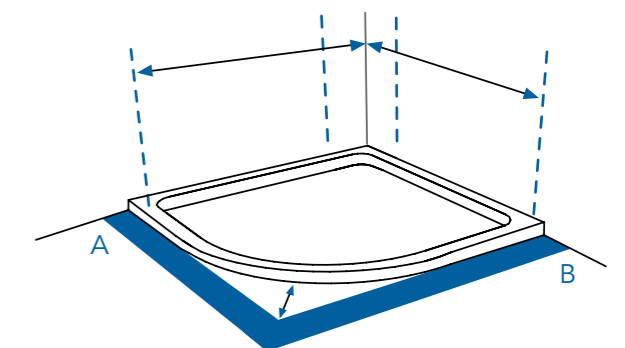

Timbers placed at right angles to determine C

Measurement

A _____ B _____ C _____

QUALITY GUARANTEED

QUALITY GUARANTEED

At Flair we have an unwavering commitment to product quality.

All Flair products are CE approved and manufactured in accordance with ISO 9001:2000 Quality Assurance systems. All glass is toughed safety glass and produced to EN12150. Flair products are performance tested to EN14428, ensuring the highest industry criteria is met.

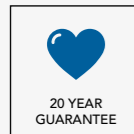

Essential Collections

Essential Collections are covered by a 20 year guarantee against manufacturer defect excluding Hydro Express.

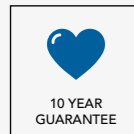

Hydro Express is covered by a 10 year guarantee against manufacturer defect.

This guarantee is valid on condition that the goods are installed and maintained in accordance with the products fitting instructions and best practices.

Non glass and detachable parts such as rollers, seals etc. are subject to normal wear and tear during usage and are under guarantee for 12 months from time of purchase.

Please complete your product guarantee card included in the components box or register online at flairshowers.com/register.

Note: Proof of purchase is necessary to validate your guarantee so retain purchase receipt for your Flair product.

If a Flair shower enclosure is defective in materials or manufacture, please contact us on +353 42 966 8000.

CLEANEASY & CLEARVUE GLASS TREATMENT SYSTEM

Essential Collections shower doors, wetroom panels and bathscreens are supplied with a special glass coating designed to reduce limescale build up and make cleaning the glass easier.



AFTERSALES & SPARE PARTS SERVICE

Flair is 100% committed to customer service excellence.

We carry a full range of spare parts for each product range and have dedicated aftersales specialists to deal with any issues you may have.

If you have any queries, please contact Flair on +353 42 966 8000.

RETURN POLICY

Flair will not accept return of any product that has been opened.

We do not accept return of any product if the packaging has been damaged.

If the product is unopened and not damaged, we will accept the return of the product but a handling fee of 25% of the invoice price will be charged.

SHOWER DOOR INSTALLATION ADVICE

BEFORE YOU INSTALL YOUR SHOWER ENCLOSURE PLEASE READ ALL INSTRUCTIONS. FAILURE TO DO SO MAY LEAD TO INVALIDATION OF YOUR GUARANTEE.

Flair Showers Ltd will not accept responsibility for any loss or damage, however caused, if the shower enclosure has not been installed as per the instructions.

- The shower tray MUST be fitted 100% level. The shower tray must be sealed correctly to prevent any water leakage.
- Glass edges are vulnerable and should be treated with care at all times. Contact with hard surfaces may result in glass breakage if due care is not taken.
- Check walls for electrical cabling or water pipes before drilling.
- Your shower enclosure, Bathscreen or wetroom must be inspected before installation. Check for all visual defects on the product before installation. Once the enclosure has been installed no claims of damage or defect will be accepted. Fitting of shower enclosure is acceptance of quality.
- The wall plugs supplied with the shower door are for use in solid walls. Timber frame, stud partition walls will require alternative fixings.
- Ensure vertical wall profiles are level and are an equal distance in from the tray.
- Shower Doors, Wetroom Screens, Bathscreens and Side Panels are adjustable between the dimensions stated. All dimensions are approximate.
- Ensure adjustment at wall profiles are equal at both sides and that all screws are fully tightened.
- Ensure hinges are level and securely fitted to the glass.
- Ensure magnets are the right orientation and are attracting rather than repelling.
- The shower enclosure should be sealed on the outside only using silicone sealant.

- Care must be taken during assembly. Flair will not accept responsibility where incorrect assembly results in undue stress being put on any components in this product.
- If there are any manufacturer defects, please call Flair Service Line on 0800 180 8050.
- Note: If a problem has been caused by incorrect installation, a call-out charge will apply for the Flair technical engineer's time. Subsequent charges will apply "to fix" a problem caused by incorrect installation.

BATHSCREEN INSTALLATION

The Bathscreen must be installed on a 100% level surface with the bath edge free from obstructions.

Bathscreens should not be used on a bath with roll top rim, stepped edge rim or where the bath handle void meets the Bathscreen seal. This will impact on the performance of the bathscreen and the guarantee will be void. The Bathscreen should be fitted to the inside edge of the bath only.

A Bathscreen acts as a water deflector and is not 100% waterproof. If used appropriately under normal showering conditions and installed to the inside edge of the bath, water will be deflected into the showering area. Bathscreens are not suitable for power showers.

SHOWER TRAY INSTALLATION

All shower trays must be installed as per instructions supplied. Install on a base of fine sand, cement and cement additive. Please note: Silicone sealants, foams, mastics, installation compound adhesive or similar must not be used as a substitute for cement. Ensure shower tray is 100% level and water test to ensure water is draining correctly. If not satisfied at any stage do not proceed with fitting. Fitting of Shower Tray is acceptance of quality.

NOTE: It is normal for a small amount of localised water to be retained on a shower tray surface after use. This should be wiped dry to prevent any build up of residue.

CLEANING GUIDELINES

- Glass: Use a soft cloth and mild detergent, rinse off thoroughly.
- Metallic Surfaces: Use a soft cloth and warm soapy water. Rinse off thoroughly.
- Do not use "Spray & leave" cleaning products on the metal surface as these will cause damage to your product. These include acidic based cleaning products, bleaches, solvents or abrasive pads. Only use detergents, cleaners and limescale removers with a pH of 5-8.
- The constant use of detergents will degrade the finish of the product over time if not thoroughly rinsed off.
- In hard water areas, regular cleaning of your Flair door will help to prevent the build-up of limescale. Stubborn deposits of limescale can be removed with the use of a mild limescale remover.
- Check your shower door for functionality periodically. Ensure that the wheel track is free from any grit/dirt which may have collected over time.

CONDITIONS OF SALE

Unless otherwise stated, all price quotations are subject to acceptance within 30 days of date of issue. Other than in the case of faulty goods / incorrect despatch, Flair will not accept the return of any product.

As part of our continuing policy of product improvement, we reserve the right to amend specifications, colours and prices without prior notice. Images are for illustrative purposes only. The colours and finishes shown in the catalogue are as accurate as possible within the limits of the printing process. The positioning of all shower heads and shower wastes in the brochure is for illustrative purposes only.

*Errors and Omissions Exempt.

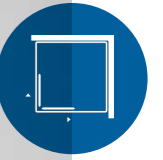

VERVE
CORNER ENTRY

SEE PAGE
24 - 25
FOR DETAILS



OVER **70** YEARS

DESIGNED
TO SUIT YOUR
SPACE AND
YOUR **BUDGET**

ESSENTIAL
WORKS
WITH
YOU

VERVE

HYDRO
EXPRESS

FLAIR
FRAMELESS

SLIMLINE
CAPELLA

CARA

UNPRICED

INSTALLERS
CHOICE
REDUCING INSTALLATION TIME

Flair Showers Ltd.
Rocks Road
Kingscourt
Co Cavan
Ireland

T +353 42 966 8000
E sales@flairshowers.com



FLAIRSHOWERS.COM
